

2011 International Conference on Green Buildings and Sustainable Cities

Harmonization between climate and architecture in vernacular heritage: a case study in Yazd, Iran

PARINAZ KESHTKARAN^{a*}

^a *Department of Architecture, Beiza Branch, Islamic Azad University, Beiza, Fars, Iran*

Abstract

In every country, heritage plays a significant role in achieving sustainable development. Iran is a vast country with different climatic zones, and, in the past, traditional builders have presented several logical climatic solutions in order to enhance human comfort. In fact, this emphasis has been one of the most important and fundamental features of Iranian architecture. To a significant extent, Iranian architecture has been based on climate, geography, available materials, and cultural beliefs. Therefore, traditional Iranian masons and builders had to devise various techniques to enhance architectural sustainability through the use of natural materials, and they had to do so in the absence of modern technologies. This paper describes the principals and methods of vernacular architectural designs in Yazd, Iran, which is located in a dry and hot area that is one of the unique geographical and cultural regions of Iran. Design and technological considerations, such as sustainable performance of natural materials, optimum usage of available materials, and the use of wind and solar power, were studied in order to provide effective eco-architectural designs for this region. The goal of this paper is to provide the architectural criteria, issues, and insights that had to be addressed in order to provide acceptable levels of human comfort in this arid area. The architectural principals that were developed and used in this extreme climate zone will be beneficial to other architects in the design of architectural structures that provide human comfort in adverse climatic conditions.

© 2011 Published by Elsevier Ltd. Open access under [CC BY-NC-ND license](https://creativecommons.org/licenses/by-nc-nd/4.0/).

Selection and/or peer-review under responsibility of APAAS

Keywords: sustainable architecture; traditional architecture; Yazd; Iran

Introduction

Iran is a high plateau that is located at latitudes in the range of 25°-40° in an arid zone in the northern hemisphere of the Earth. The dry deserts of northern Africa and Saudi Arabia extend from the Atlantic

* Corresponding author. Tel.: +989173093891

E-mail addresses: par.keshtkaran@gmail.com

Ocean in western Africa across Iran and finally end in Afghanistan and Turkmenistan.

After extensive studies, Iranian environmental professors have proposed four climatic categories from an architectural perspective:

- 1. Hot-dry climate (central plateau of Iran)
- 2. Mountainous cold climate (mountainous parts of western Iran)
- 3. Humid and moderate climate (southern borders of the Caspian Sea)

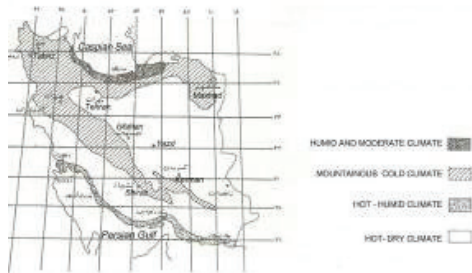

Fig.1. climatic zone of Iran

- 4. Hot-humid climate (northern borders of the Persian Gulf and the Oman Sea)

The weather in most of Iran's central plateau is hot and arid (Fig. 1), and many historical cities that have valuable architectural designs are located in this hot and arid region. The origins of some of these cities, such as Yazd and Naen, can be traced back to pre-Islamic era. The different characteristics of the four climatic regions of Iran have had significant effects on the architectural designs and building materials used in cities of the regions. For the most part, the people in these areas have developed and used effective solutions over the centuries in order to create architectural compatibility with the climate in the area. Amazingly, these solutions have controlled the annoying aspects of the oppressive climatic conditions and even created some useful and favorable environmental aspects that the people enjoy.

Generally, structures in this region have been logically integrated with nature, and, as a result, the traditional buildings in Iran, unlike most modern buildings, are compatible with and have a harmonious relationship to the natural conditions. The world's most oppressive deserts are located in the center of the large and closed cradle of Iran's plateau, at the center of Yazd Province. In fact, Yazd Province is surrounded by large deserts, such as Loot and Dashte Kavir. The city of Yazd is known as the desert capital, and, since Yazd is in the desert, the architecture in the city closely resembles the architecture used in various desert locations. [2](Kasmaee,1984) The purpose of this article is to evaluate the effect of climatic factors on construction and the local architecture in hot-arid regions, with a special focus on Yazd City.

1. ABOUT THE REGION

1.1. Geographical position of Yazd Province:

Yazd Province is located in central Iran, between geographical latitude of 29°48' to 33°30' north and longitude of 52°45' to 56°30' east of the meridian origin. The area of Yazd Province is approximately 72,000 square kilometers, or more than four percent of the total area of the country.[2] (Kasmaee,1984)

2. Logical formation of architectural texture in Yazd City in accordance with climatic issues

In examining the architecture of cities and villages in hot and arid areas, climate is an important logical factor that must be considered in the architecture of urban areas, and it has always had a major effect on

the decision making of the people who live in these regions. The oppressive climate made it necessary for people to search for solutions over thousands of years, and they have managed to have great success in reducing the annoying aspects of the oppressive environment and in putting its favorable aspects to beneficial use. The major problems that forced the people of Yazd Province people to search for effective solutions were the burning sun, excessive heat, high temperatures during the day, and low temperatures at night (especially during the summer), hot summers and cold winters, the arid weather that results from very little rainfall, dehydration, and frequent sand storms. One valuable solution for dealing with the climate issues in the hot-arid regions of Iran, especially Yazd Province, is described below. In addition to the necessity of defending against enemy attacks, the people must find ways to deal with the socio-economic issues of urban relationships, which contributes significantly to the closed urban complex structure, which also exists in some rural areas. The need to protect people from the heat and burning sun of summer by creating shady areas had a significant effect on the architectural construction techniques used in these areas, and the combination of villages and cities can be seen as a dense mass that has been designed to minimize exposure to direct sunlight. The architectural plan is to make buildings dense and complex, providing maximum protection from the weather in the winter and in the summer and casting the most shadows on the houses and across the streets. [6](Tavassoli,2002) (Fig.2)



Fig.2. (a) urban texture; (b)The historic core of Yazd city

2.1 Sidewalks

To protect people from the heat, streets and sidewalks are constructed mainly in the east–to–west direction. On hot summer days, the narrow sidewalks with high walls on both sides are completely in the shadows. [6] (Tavassoli,2002) (Fig 3)



Fig .3. (a) The renovated street of Yazd ;(b) Sidewalk in historic core of Yazd

To prevent the hot air from flowing down the streets and sidewalks and entering the buildings, the sidewalks are mostly curved and narrow with high walls. Roofed sidewalks (Sabat) help keep the sidewalks in the shadows, and narrow sidewalks contribute to the density of nearby buildings. These

narrow passages with high walls provide an effective solution for dealing with the harsh climate. [4] (Moradi , 2005)(Fig.4)



Fig.4. (a)Sabat , Yazd; (b) renovated Sabat , Yazd

2.2 Openings

The numbers of windows that open to the sidewalks are minimized to avoid having the unfavorable climate penetrate into the indoor area. To prevent dust and excessive sunlight from getting into the buildings, windows and openings are usually placed in the ceiling or high up the walls. Most of the windows open to the protected central courtyard area, which generally has less harsh conditions and a more favorable environment than exist on the outside of the buildings. [3] (Meamarian,1999) (Fig. 5)



Fig.5. House of Kolahdooz, Yazd

2.3 Materials

What attracts tourists and viewers of Yazd at first is the role of mud and molded materials (especially adobe) everywhere in the houses, on the sidewalks, and on the wind towers. Everything in Yazd has been designed to use construction materials that are formed from mud. Because of the climatic conditions, the use of mud materials in the desert, and especially in Yazd, is feasible and practical. Nothing is as resistant against the burning sun in these regions as adobe and mud, because rooms can be warmed with little internal heat during the cold-dry seasons. The main reasons for using these materials are that they are available and practical for applications in desert conditions.

Adobe and mud have high thermal capacity, which is important because it takes a long time for the heat outdoors to pass through the walls and get into the indoor spaces of the houses. Adobe can delay the

heat transfer from outside to inside for about eight hours, which means the heat that is accumulated in the walls during the day will warm the house at night when the outside temperature decreases. In critical conditions, buildings are built underground or in the heart of the hills so they will be less affected by the adverse weather conditions. [3] (Meamarian,1999) [4] (Moradi , 2005) (Fig. 6a)

2.4 Facade

Light colors are used for the façade of buildings because they absorb less heat. Smooth and glossy surfaces are also used to reflect light. Current practice is to use plaster, raw clay, and hay to coat the walls. [4] (Moradi , 2005) (Fig.6b)



Fig.6. (a) Traditional material, Yazd; (b) Outside facade of traditional house, Yazd

2.5 Courtyard

In hot-arid regions, houses with courtyards are a time-tested and valuable design pattern. This approach has been used from pre-historic times in central Iran, in other dry parts of the Middle East, and by most ancient civilizations. Houses with surrounded central yards are the most beneficial form for decreasing the exposure to harsh weather conditions, especially in hot, arid regions and in deserts. The rooms that open to the yard are usually protected against the extreme heat of the summer, the cold of the winter, and from wind, storms, and sand in desert regions. [3] (Meamarian,1999) (Fig.7)



Fig.7. The house of Rasoulian, Yazd

2.6 Summer area and winter area

Nature is an inseparable part of people's lives. It forces families to move to different parts of the house in different seasons. So, houses are divided into two parts, a summer area and a winter area. This feature can be seen in the houses in most cities of this region. In most houses in Yazd, the main part of the houses faces northeast. In the summer, the main part of the house is the summer area, which is in the shadows most of the time. Across the yard from the summer area is the winter area, which provides access to the warmth of the sunlight during the winter. The owner builds the two other parts depending on her or his

financial status. Houses with yards in the middle and two other areas that connect the summer area and the winter area are called four-season houses. But the summer area best demonstrates the importance of the art of architecture in protecting people from adverse climatic conditions. [6] (Tavassoli,2002) (Fig. 8)

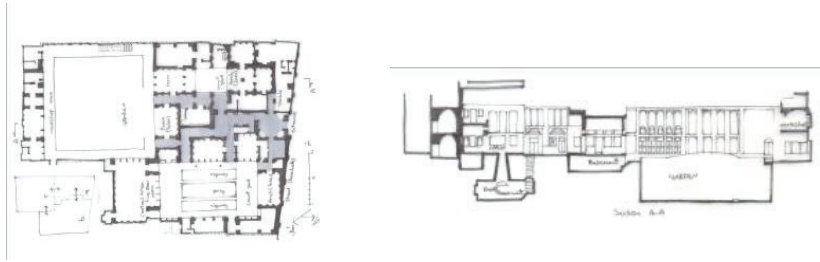

Fig.8. (a) The house of Zoroastrian, Yazd (section); (b) The house of Zoroasterian, Yazd (Plan)

The veranda is a part of the house that is used on summer evenings when the sun has passed below the front wall. It usually is elevated three or more steps higher than the yard, so it is slightly raised above the yard. The basement vent is under the steps of the summer area. [3](Meamarian,1999)(Fig. 9)



Fig. 9. The house of Kolahdooz, Yazd

2.7 *Godalbaghche (Very pit yard)*

In a traditional house, the yard is built very deep and is called Godalbaghche. Sometimes the depth of the yard is as much as 3-4 meters. [3] (Meamarian,1999) (Fig. 10a)

2.8.1 *Reasons for using Godalbaghche*

Increasing the height of the walls of the yard increases the height of the shade and helps to keep the air cool air in the yard during the day.

It also facilitates access to the subterranean canals that are used to water the plants and gardens in the yard. By building Godalbaghche, the access that people have to the central yard, the branches and leaves of the trees, and the humidity and shade is increased.(Moradi , 2005) (Fig.10b)

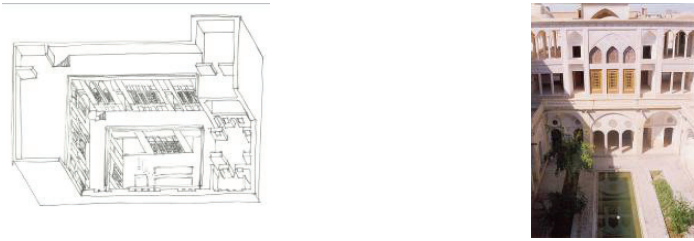

Fig.10. (a)The house in Darband-e-lariha, Yazd; (b) A house with Godalbaghche

2.8 Roof cover

The lack of rainfall and wood in Yazd are the reasons that roofs are made into arched or domed shapes using adobe and mud. Because the prominence of domed roofs means that they are constantly exposed to the flow of air caused by the wind, it is a useful way to reduce the heat of the roof due to severe sun radiation. At night, it helps the roof to cool faster as well. In the domed or cylindrical roofs, the sun radiation is not the same on all sides, because part 3 always receives less heat than part 1 (Figs.11). This is also useful in reducing the temperature under the roof. [4] (Moradi , 2005)



Fig.11. (a)The Roof of traditional building, Yazd; (b) Diagram of roof function

2.9 Air trap (Wind tower)

Natural features of Yazd include harsh, high-speed winds and sometimes sand storms. That's why architects must consider favorable and unfavorable winds. They use the favorable winds in hot seasons with the help of the air trap. One of these favorable winds is known as the Isfahani wind, which moves in the northwest direction. The air trap is an architectural element that has a climate function.[5] (Mahmoodi,2009) (Fig. 12)

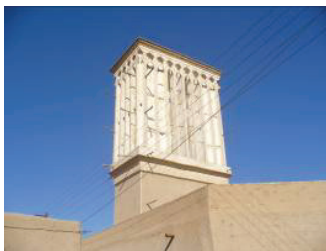

Fig.12. Air trap, Yazd

Mr. Gholam Hossein Memarian divided air traps into two categories:

- Purely functional air traps
- Symbolic and functional air traps

The first category can be found in most typical houses in Yazd and areas around it, such as Ardakan and Meibod. In the two cities mentioned above, one-way air traps that have their own unique form are used.

The second category can be found in some Yazd houses and in the houses of other cities nearby. In addition to its function as an air trapper, it indicates the landlord’s financial status. The size of some of air traps exceeds the size of a three-door room!

Each constituent element of the air trap has an effect on the final shape of the air trap.

From bottom to the top, an air trap includes these parts:

Stokehole, stalk, chest, chain, and shelves. (Fig. 13a) Since the framework of the air trap is built higher than the height of the building itself and the sucking holes reduce its strength against lateral powers, the importance of resistance of the elements mentioned above is obviously significant. For building a Yazd air trap, a wooden ram is placed horizontally in bricks, and this obviously increases its resistance against lateral forces. [3] (Meamarian,1999) (Fig. 13b)

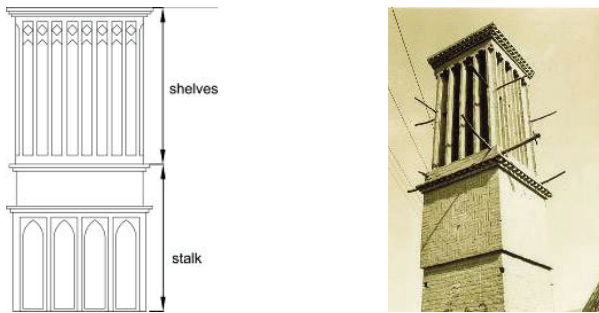

Fig.13. (a)Air trap’s part ; (b) Air trap’s wooden ram

2.9.1 Functions of air traps

The functions of air traps are primarily to receive the favorable wind for cooling and ventilation and to direct it to spaces such as the main room, basement, and water storage area. The opening of the air trap, which faces the wind, has positive pressure applied, and the opening on the side opposite to the incoming wind has a pressure that is less than the ambient atmospheric pressure (the suction part). (Fig. 14)



Fig.14. (a) 3D modelling of air trap; (b) Wind circulation

The middle septum of the air trap separates the suction part from the pressure part. The wind that enters hits the vertical septum in the middle of the air trap and directs the air to the indoors space through channels that face the wind. It should be mentioned that a group of air traps cool the indoor space just by convection, while others cool the air via evaporation in addition to the convection. A pool filled with water is built under the air trap channels, so the wind that enters through the channels passes over the surface of the water and cools the air by transferring some of its heat energy into the water to effect evaporation of the water. The increase in humidity that results from the evaporation of the water in arid regions is in great importance. The air that is used indoors absorbs heat from the environment, and the reduced pressure in the back channels causes the air to be rapidly removed, causing an inflow of air through the front openings to replace the used air inside. [5] (Mahmoodi , 2009) [4] (Moradi , 2005)

3. The effect of climate factors

Heat radiation (shining) – heat – wind – humidity

As an example in Yazd: To prevent the extra heat of summer, especially during the very hot afternoon period, the summer section (the part in which families spend more time) is built with its back to Qibla (back to the south), which is called “Nesar” in the native language.

The other side, which is in front of Qibla, is perfect for the winter sunshine. The yard is a pit below the ground level, because the height of the walls of the rooms in all four parts of the house, so it is in the shadows on hot summer days. In addition, at night when the weather is cool, the deep (pit low) yard becomes cool and stays cool for several hours, until the sun is shining almost directly from above. The coolest part of the house is the basement, which is underground and cool even in the summer, so it is enjoyable to spend hot summer days in a place that is so cool that sometimes it can feel uncomfortable. There is an air trap, located in the back part of the summer section, through which air flows into the house, and, in some houses, the air is directed to the basement as well. Having a pond in the yard and some plants or a little garden creates evaporative cooling, and, with the help of the air trap, the cool, humid air flows in the house, creating a pleasant environment. On summer nights, when people usually sleep on the roof or in the yard, the air trap gets the cold, night winds and spreads the cold air all over the house, and since the doors are closed, the house remains cool during the morning.[6](Tavassoli,2002)(Fig 15)

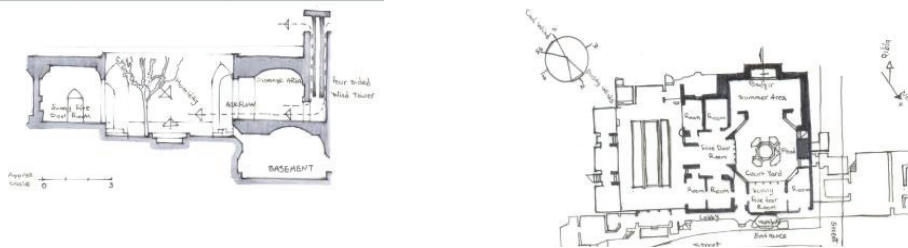
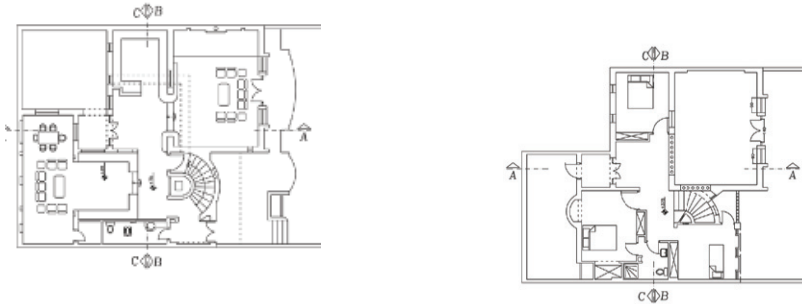

Fig.15. (a)The house of Arabha , Yazd (section); (b) The house of Arabha, Yazd (Plan)

4. Using vernacular architectural design directions in Yazd

The house of Ayatollahi in the Safaee quarter in Yazd was designed to be compatible with the local climate. This house faces southeast at an angle 27° in 13m x25m dimensions. Some modern architecture ideas are based on traditional, native architecture. The area of the front yard is 150 m², and there is also a backyard with tall walls to provide shade during the day and ventilation air in the summer. The living

room has a high ceiling and is connected to the bedroom on the first floor, which help the hot air rise and spread on the first floor. On sunny days the outdoor and indoor curtains are lowered, while, after sunset, they are raised. Hence, in summer, the process will be reversed. Two horizontal channels that are perpendicular to each other, one from the storehouse in basement and the other from the lowered yard that is connected to the small basin, have a way to the living room, ending at a well with a depth of 3 m at their interchange point. The channel that leads to the pool is half filled with water, and the overflow goes into the well, always keeping it damp. So the air gets humid at 24° C and streams into the living room. [1]



(Gharehbolchian, 2010). (Figs. 16-17)

Fig.16. (a)The house of Ayatollahi (ground floor plan); (b) The house of Ayatollahi (first floor plan)

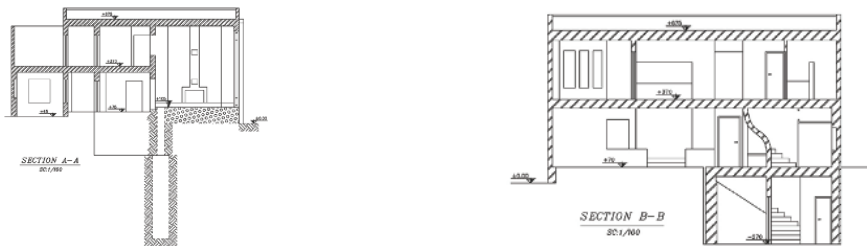

Fig.17. (a)The house of Ayatollahi(section A-A); (b) The house of Ayatollahi(section B-B)

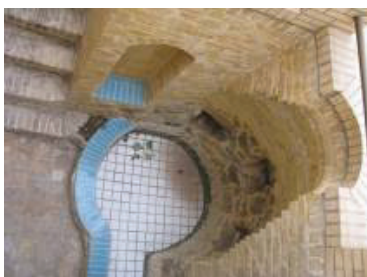

Fig.18. The pond located in north yard

Fig. 18 shows the little pool (small basin) and the underground channel that leads to the lowered northern yard .It streams the cool air to the living room with the help of the air that has been cooled by giving up its heat to evaporate water. In the summer, the cool air of the basement comes up through the vertical channels, and, in the winter, the fan and the heater in the basement provide warm air to the

bedrooms through this channel. Natural ventilation occurs when the north and south windows are opened during the evenings and nights in summer, and the cool air is saved in the house for the morning hours. In the morning, while all the windows are covered by the curtains to prevent light from coming in, the window of the main bedroom is open and acts as a chimney to remove the hot stream of air, and the cool air of the north direction and deep-ground yard replace the hot air. [1] (Gharehbolchian, 2010)

5. Conclusions

The direction of the house in a hot, dry climate should be designed in a way to protect the building from the hot sunshine on summer afternoons.

If the building is to be constructed in one direction, 25° east is the best direction for the main body of the building, but this can be changed to as much as 35° southeast.

A useful, significant part, such as a porch as a half-open space, can be used in hot, arid regions in the summer. Also, a small, closed space (small indoor space) on the first floor, which is usually cool, can serve the same purpose as a basement.

Another way to reduce the extreme heat on the west side of the building is to use a disordered arrangement of the bricks and provide deep, low shade on the walls.

In Iranian architecture, this construction approach is used to reduce the heat and as a way to make some changes on the appearance of buildings; also, it disguises the lack of smoothness of the walls.

The best indoor heat balance can be gained by using heavy construction materials in the living areas, which are used during the day, and light construction materials in the bedrooms where people sleep at night.

One reason for using high roofs in hot regions is that warm air rises, so high roofs can provide a positive effect.

Acknowledgements

I would like to thank the personnel of the Regional Information Center for Science and Technology and for helping us to gather the data and articles.

References

- [1] Gharehbolchian, A. 2010. *Concept of solar sustainable heat and cool*. The first national conference of contemporary architecture & urbanization. Shiraz. Iran.
- [2] Kasmaee M. *Architecture and Environment*. Tehran. khane sazi iran; 1984, p. 153-170.
- [3] Meamarian, G.H. Residential architecture of Iran. Tehran. The University of Science & industry; 1999, p. 239-347.
- [4] Moradi S. *Environmental control system*. Tehran. Ashiyan ; 2005, p. 34-41, 55-57, 128-134.
- [5] Mahmoodi M. *The air trap*. Tehran. Yazda ; 2009, p. 25-40.
- [6] Tavassoli M. Urban structure and architecture in the hot arid zone of Iran. Tehran. Payam & Peivand; 2002, p. 27-48.