

# Optimization of capacity and operation for CCHP system by genetic algorithm

Jiang-Jiang Wang\*, You-Yin Jing, Chun-Fa Zhang

School of Energy and Power Engineering, North China Electric Power University, Baoding, Hebei Province 071003, China

## ARTICLE INFO

### Article history:

Received 11 May 2009

Received in revised form 28 July 2009

Accepted 1 August 2009

Available online 26 August 2009

### Keywords:

Combined cooling heating and power (CCHP) system  
Optimization  
Capacity  
Operation strategy  
Genetic algorithm (GA)

## ABSTRACT

The technical, economical and environmental performances of combined cooling, heating and power (CCHP) system are closely dependent on its design and operation strategy. This paper analyzes the energy flow of CCHP system and deduces the primary energy consumption following the thermal demand of building. Three criteria, primary energy saving (PES), annual total cost saving (ATCS), and carbon dioxide emission reduction (CDER) are selected to evaluate the performance of CCHP system. Based on the energy flow of CCHP system, the capacity and operation of CCHP system are optimized by genetic algorithm (GA) so as to maximize the technical, economical and environmental benefits achieved by CCHP system in comparison to separation production system. A numerical example of gas CCHP system for a hotel building in Beijing is given to ascertain the effectiveness of the optimal method. Furthermore, a sensitivity analysis is presented in order to show how the optimal operation strategy would vary due to the changes of electricity price and gas price.

© 2009 Elsevier Ltd. All rights reserved.

## 1. Introduction

Combined cooling, heating and power (CCHP) system is broadly identified as an alternative for the world to meet and solve energy-related problems, such as increasing energy demands, increasing energy cost, energy supply security, and environmental concerns [1–6]. A good CCHP system must yield economical savings, but more importantly must yield real energy savings as well as reducing the emission of pollutants. The performance of CCHP system is closely dependent on its design and operation. Aiming to maximize the benefits from CCHP system in comparison to traditional separation production (SP), it is necessary to optimize the design and operation strategy.

Many studies have been reported on this topic. Better performances (e.g. operations cost, carbon dioxide emission reduction (CDER), and primary energy consumption (PEC)) can be obtained when the optimization was applied to design and/or operate CCHP systems. The optimized CCHP systems have different components. For example, the prime mover includes gas turbine [7–9], steam turbine [10,11], gas engine [12,13], a steam Rankine process using biomass fuels [14], and the cooling system adopts compression [15], absorption [7,15], and ejector refrigeration cycle [11], etc.

The typical optimization algorithms used in CCHP systems are usually divided to linear programming and non-linear programming. The linear algorithm is easily applied to CCHP system optimization [16–19]. The mixed integer non-linear programming model is another common optimization method [9,10,14,15,20,21], which considers the non-linear characteristic and solves

the non-linear problems. There are other optimization methods such as sequential quadratic programming [8], tri-commodity simplex algorithm [17], extended power simplex algorithm [18], Lagrangian relaxation [22] and genetic algorithm (GA) [23,24]. More importantly, the objective function in optimization process guides and determines the optimal result in some extent. Usually, the objective function is expressed in different terms of net cash flow, primary energy saving [25], total cost rate [8], annual total cost [9], energy cost [7,26], exergetic efficiency and gross benefit [27], as well as carbon dioxide emissions costs [17]. Generally, the benefits achieved by CCHP system are maximized from economy, energy consumption and environment.

This paper presents the general energy flow model of CCHP system and the evaluation criteria including technology, economy and environment. Then the objective function of the integrated performance of CCHP is constructed and GA is employed to optimize its design capacity and operation. This paper is organized as follows. Section 2 presents the mathematical analysis of the CCHP system and the evaluation criteria of CCHP systems in comparison to SP. Section 3 proposes the optimization problems and constructs the GA optimization method. Section 4 applies GA to optimize the CCHP system providing three products to a commercial building in Beijing, China. Some comments are concluded in the last section.

## 2. CCHP system

### 2.1. Energy flow of CCHP system

The CCHP system consists of a power generation unit (PGU), a waste recovery system, a back-up boiler, cooling system and

\* Corresponding author. Tel.: +86 312 7522443; fax: +86 312 7522440.  
E-mail address: [jiangjiang3330@sina.com](mailto:jiangjiang3330@sina.com) (J.-J. Wang).

### Nomenclature

ATCS	annual total cost saving
CCHP	combined cooling heat and power
CDE	carbon dioxide emission
CDER	carbon dioxide emission reduction
COP	coefficient of performance
GA	genetic algorithm
PGU	power generation unit
PES	primary energy saving
SP	separation production

### Symbols

$C$	cost
$E$	electricity
$F$	fuel
$N$	installation capacity
$Q$	heat
$R$	capital recovery factor
$\eta$	efficiency
$\mu$	CO <sub>2</sub> emission conversion factor

### Subscripts

$ac$	absorption chiller
$b$	boiler
$c$	cool
$e$	electricity
$ec$	electric chiller
$f$	fuel
$grid$	electricity grid
$h$	heat
$p$	pump
$pgu$	power generation unit
$r$	recovery heat
$rc$	the part of recovery heat for cooling
$rec$	waste heat recovery system
$rh$	the part of recovery heat for heating
$x$	ratio of electric cooling to cool load

### Superscript

SP	separation production
----	-----------------------

heating system, which is shown in Fig. 1. Here the cooling system adopts the combination of electric chiller and absorption chiller because the excess electricity may be usually produced by CCHP system following thermal demand and the excess electricity is not allowed to be sold back to grid in China. The CCHP system operates following thermal demand, which is a common and simple operation strategy [28]. The PGU is driven by natural gas and produces the electricity to building. The high-temperature exhaust gas of PGU is recovered to accommodate the thermal load for cooling in summer and heating in winter. If the heating does not completely satisfy the application needs, a supplementary boiler can be used. Similarly, when the amount of generated electricity by PGU is not enough, the additional electricity comes from the local grid. On the contrary, when there are excess heat or electricity produced by CCHP system, the excess energy products are dissipated from CCHP system. Consequently, the operation of PGU must reduce the excess products when it satisfy one energy demand of building.

The balance of the electric energy in CCHP system is expressed as

$$E_{grid} + E_{pgu} = E + E_p + E_{ec} \quad (1)$$

where  $E_{grid}$  is the electricity from grid in CCHP system (when PGU generates the excess electricity,  $E_{grid}$  is negative and its value is equal to the excess electricity). The treatment of the excess electricity is explained in the last assumptions of Section 2.1),  $E_{pgu}$  is the

generated electricity by PGU,  $E$  is the electric energy use (lights and equipments) of building,  $E_p$  is the parasitic electric energy consumption of CCHP system, and  $E_{ec}$  is the electric energy consumption for electric chiller providing cool to building.

The electricity used by electric chiller is calculated as

$$E_{ec} = \frac{Q_{ec}}{COP_e} \quad (2)$$

where  $Q_{ec}$  is the cooling produced by the electric chiller, and  $COP_e$  is the electric chiller's coefficient of performance (COP).

The PGU fuel energy consumption,  $F_{pgu}$ , can be estimated as

$$F_{pgu} = \frac{E_{pgu}}{\eta_e} \quad (3)$$

where  $\eta_e$  is the PGU generation efficiency.

The recovered waste heat from the prime mover,  $Q_r$ , can be calculated as

$$Q_r = F_{pgu} \eta_{rec} (1 - \eta_e) \quad (4)$$

where  $\eta_{rec}$  is the heat recovery system efficiency.

The heat supplied to the cooling system and heating coil is

$$Q_r + Q_b = Q_{rc} + Q_{rh} \quad (5)$$

where  $Q_b$  is the supplementary heat from the boiler,  $Q_{rc}$  and  $Q_{rh}$  are the heat supplied to absorption chiller and heating coil, respectively.

The heat required by the absorption chiller and heating coil to handle a part of cooling load and all heating load are estimated respectively as

$$Q_{rc} = \frac{Q_{ac}}{COP_{ac}} \quad (6)$$

and

$$Q_{rh} = \frac{Q_h}{\eta_h} \quad (7)$$

where  $COP_{ac}$  is the absorption chiller's COP,  $Q_{ac}$  is the cool produced by absorption chiller,  $Q_h$  is heat demand for space heating and domestic hot water, and  $\eta_h$  is the efficiency of heating coil (here to simplify the calculation, it is assumed that the transmission efficiency of domestic hot water is equal to  $\eta_h$ ).

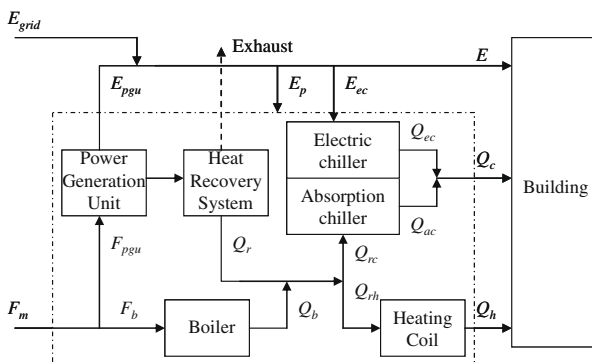

Fig. 1. Energy flow diagram of CCHP system.

The supplementary fuel energy consumption to the boiler,  $F_b$ , can be estimated as

$$F_b = \frac{Q_{rc} + Q_{rh} - Q_r}{\eta_b} \quad (8)$$

where  $\eta_b$  is the back-up boiler efficiency.

The balance of the cool load of building is expressed as

$$Q_c = Q_{ec} + Q_{ac} \quad (9)$$

where  $Q_c$  is the cool demand for space cooling.

Here  $x$  is defined to the ratio of cool provided by electric chiller to the cool load and it is expressed as

$$x = \frac{Q_{ec}}{Q_c} \quad (10)$$

and it is called the ratio of electric cooling to cool load here. When  $x = 0$ , the cooling system adopts absorption chiller, and when  $x = 1$ , the electric chiller is employed to provide cool for building. Otherwise, the cooling system adopts mixed chillers.

Therefore, the on-site fuel energy consumption,  $F_{on-site}$ , is calculated as

$$F_{on-site} = F_{pgu} + F_b \quad (11)$$

and, the total fuel energy consumption is

$$F = F_{on-site} + \frac{E_{grid}}{\eta_e^{SP} \eta_{grid}} \cdot U \quad (12)$$

where  $\eta_e^{SP}$  is the generation efficiency of SP,  $\eta_{grid}$  is the transmission and distribution efficiency of electricity grid, and

$$U = \begin{cases} 1, & E_{grid} \geq 0 \\ 0, & E_{grid} < 0 \end{cases}$$

Assuming to the maximum input fuel energy,  $F_{max}$ , of the PGU, the operating conditions and the achievable results are expressed in the terms of the total fuel energy consumption in Eqs. (1)–(12) as follows:

$$\text{Test condition: } \frac{(1-x)Q_c}{COP_{ch}} + \frac{Q_h}{\eta_h} \geq F_{max}(1-\eta_e)\eta_{rec} \quad (13)$$

If Test condition = True then

$$F = F_{max} + \frac{\frac{(1-x)Q_c}{COP_{ch}} + \frac{Q_h}{\eta_h} - F_{max}(1-\eta_e)\eta_{rec}}{\eta_b} + \frac{E_{grid}}{\eta_e^{SP} \eta_{grid}} \cdot U \quad (14)$$

where  $E_{grid} = E + E_p + \frac{xQ_c}{COP_e} - F_{max}\eta_e$ .

If Test condition = False then

$$F = \frac{\frac{(1-x)Q_c}{COP_{ch}} + \frac{Q_h}{\eta_h}}{(1-\eta_e)\eta_{rec}} + \frac{E_{grid}}{\eta_e^{SP} \eta_{grid}} \cdot U \quad (15)$$

where  $E_{grid} = E + E_p + \frac{xQ_c}{COP_e} - \frac{\frac{(1-x)Q_c}{COP_{ch}} + \frac{Q_h}{\eta_h}}{(1-\eta_e)\eta_{rec}} \eta_e$ .

In this study, the capacity of PGU selected in the design stage,  $F_{max}\eta_e$ , and the fixed ratio of electric cooling to cool load used in operation stage,  $x$ , are optimized. The reason of selecting capacity of PGU is that the sizing of CCHP plant is important to capital cost and operation mode. After the capacity of PGU is determined, the capacity of heat recovery system and boiler, etc., are naturally obtained. Because the generation efficiency of PGU is assumed to be constant in the following section,  $F_{max}$  is selected to be optimized by GA. The fixed ratio of electric cooling to cool load aims to construct the simple operation strategy. When  $x$  is changed with time and not constant, the operation mode will be more complicated and it requires more advanced and complicated control system. Therefore, the fixed ratio is selected to be optimized.

During the optimal analysis of CCHP system, some important assumptions are followed:

- (1) The minimum technical limit of CCHP system is neglected. The CCHP equipments can operate anywhere between 0% and 100% of its rated capacity, and ramping rate for load adjustment is not included.
- (2) The CCHP system is assumed to be 100% reliable.
- (3) The efficiency drops of CCHP equipments at part load operation are neglected to simplify the analysis and calculation.
- (4) The CCHP system operates following thermal demand. When PGU runs in this strategy, CCHP system may produce excess electricity that can usually be exported or stored for future use. But the electricity generated by micro-CCHP system for building is not allowed to be sold back to grid in China. Consequently, it is assumed that the excess electricity is not sent to grid in this analysis. However, the excess electricity is not technically dissipated directly when CCHP system runs following the thermal demands. Therefore, the additional electricity can be stored or sent to other nearby users. But the energy saving or economical saving of the excess electricity is not considered into the analysis of the independent CCHP system.

## 2.2. Evaluation criteria

To carry out this analysis, an existing conventional SP system, as a reference system, is compared to the CCHP system. The energy flow of SP is as follows: the electricity needed by building comes from the local electricity grid, the cooling system adopts the electric chiller, and the heat comes from gas boiler and is distributed to users through heating coils. Therefore, the primary energy consumption of SP is calculated as:

$$F^{SP} = \frac{E}{\eta_e^{SP} \eta_{grid}} + \frac{E_p^{SP}}{\eta_e^{SP} \eta_{grid}} + \frac{Q_c}{COP_e \eta_e^{SP} \eta_{grid}} + \frac{Q_h}{\eta_b^{SP} \eta_h^{SP}} \quad (16)$$

where  $E_p^{SP}$  is the additional electrical energy use of distribution equipments such as pumps and fans in SP system,  $\eta_b^{SP}$  and  $\eta_h^{SP}$  are the efficiencies of boiler and heating coil, respectively.

To measure the benefits from technology, economy and environment, achieved by CCHP system in comparison to SP, the following evaluation criteria are used.

- (1) Primary energy savings (PES)

PES is defined as the ratio of the saving energy of CCHP system in comparison the SP system to the energy consumption of SP. It can be written as

$$PES = \frac{F^{SP} - F}{F^{SP}} = 1 - \frac{F}{F^{SP}} \quad (17)$$

- (2) Annual total cost saving (ATCS)

The annual total cost, which includes the annual capital cost and the annual energy charge, is calculated

$$ATC = R \times \sum_{k=1}^l N_k C_k + \sum_{i=1}^{365} \sum_{k=1}^{24} (E_{ik,grid} C_{ik,e} + F_{ik} C_{ik,f}) \quad (18)$$

where  $N$  and  $C$  are the installed power of equipment and the initial capital cost of each kind of equipment, respectively,  $l$  is the number of equipments,  $C_{ik,e}$  and  $C_{ik,f}$  are the hourly energy charges of electricity and natural gas, respectively, and  $E_{ik,grid}$  and  $F_{ik}$  are the hourly demands of the electricity bought from grid and the natural gas.

The capital recovery factor,  $R$ , is defined to:

$$R = \frac{i(1+i)^n}{(1+i)^n - 1} \quad (19)$$

where  $i$  is the interest rate and  $n$  is the service life of the equipment. Herein it is assumed that the values of  $i$  and  $n$  are equal to all kinds of equipment.

Similarly,  $ATCS$  is defined as the ratio of the saving annual total cost of CCHP system in comparison to the SP to the annual total cost of SP. It can be written as

$$ATCS = \frac{ATC^{SP} - ATC}{ATC^{SP}} = 1 - \frac{ATC}{ATC^{SP}} \quad (20)$$

where  $ATC^{SP}$  is the annual total cost of SP.

(3) Carbon dioxide emission reduction (CDER)

The amount of carbon dioxide emission (CDE) from CCHP system can be determined using the emission conversion factors as follows [29,30]:

$$CDE = \mu_{CO_2,f}F + \mu_{CO_2,e}E_{grid} \quad (21)$$

where  $\mu_{CO_2,f}$  and  $\mu_{CO_2,e}$  are the emission conversion factors of natural gas and electricity from grid, respectively.

Referred to the definition of  $PES$  and  $ATCS$ , the amount of CDER of CCHP system in comparison to SP can be calculated as follows:

$$CDER = \frac{CDE^{SP} - CDE}{CDE^{SP}} = 1 - \frac{CDE}{CDE^{SP}} \quad (22)$$

where  $CDE^{SP}$  is the amount of CDE from SP.

### 3. Optimization

This paper attempts to solve the optimal problem of CCHP utilizing the method of mathematical programming. The integrated performance of CCHP system is considered and amplify the benefit achieved by CCHP system in comparison to the SP system. The following objective function, namely the fitness function in GA, is defined to maximize the benefits of CCHP system from technology, economy and environment:

$$\max U_{fitness} = \omega_1 \cdot PES + \omega_2 \cdot ATCS + \omega_3 \cdot CDER \quad (23)$$

where  $\omega_1$ ,  $\omega_2$  and  $\omega_3$  are the weights of  $PES$ ,  $ATCS$  and  $CDER$ .

The fitness function is defined as the weighted sum of  $PES$ ,  $ATCS$  and  $CDER$ , which is related to the primary energy consumption, fuel expense, capital cost, and emission conversion factors. It is the evaluation function of population during the evolution in GA. In the programming, the minimum objective function is adopted so that the maximum function in Eq. (23) is changed to:

$$\min J = \frac{1}{U_{fitness}} \quad (24)$$

GA is a search technique used in computing to find exact or approximate solutions to optimization and search problems. First pioneered by John Holland in the 1960s, GA has been widely applied in bioinformatics, phylogenetics, computational science, engineering, economics, chemistry, manufacturing, mathematics, physics and other fields [11,31–38]. GAs are a particular class of evolutionary algorithms (also known as evolutionary computation) that use techniques inspired by evolutionary biology such as inheritance, mutation, selection, and crossover. Simple generational genetic algorithm procedure is to:

- (1) Choose initial population.
- (2) Evaluate the fitness of each individual in the population.

- (3) Repeat until termination: (time limit or sufficient fitness achieved)
  - Select best-ranking individuals to reproduce;
  - breed new generation through crossover and/or mutation (genetic operations) and give birth to offspring;
  - evaluate the individual fitnesses of the offspring;
  - replace worst ranked part of population with offspring.

The optimization procedure of CCHP system in GA is shown in Fig. 2. Characteristic parameters of CCHP system (such as PGU efficiency, COP of cooling system, and CDE), energy demands of building, cost parameters (such as cost of fuel and electricity, and capital cost of equipments) and GA parameters (population size, evolutionary generations, crossover probability, and mutation probability, etc.) are given at the beginning. The initial values of variables,  $F_{max}$  and  $x$ , are presented and they are coded in 0/1 strings corre-

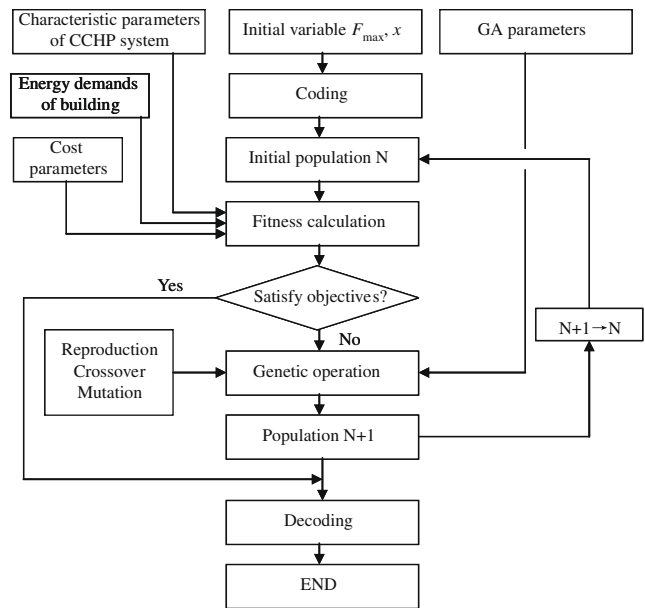

Fig. 2. Flow chart of CCHP system's optimization in GA.

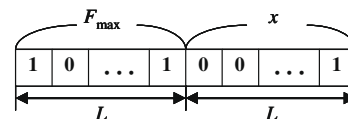

Fig. 3. Coding structure of variables.

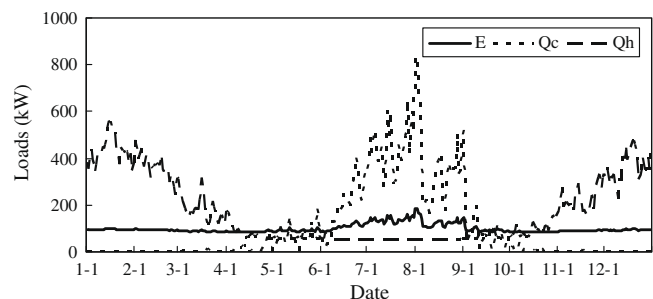

Fig. 4. Daily loads of the hotel in Beijing.

sponding to the values of genes. The coding form is shown in Fig. 3.  $L$  is the number of genes. Then, the objective function is evaluated. With each searching step, the operational strategy is assessed and the annual energy charge is evaluated by the comprehensive relationships of load demands, system performance characteristics and energy balance of the whole system. Optimal values of capacity of PGU and ratio of electric cooling to cool load are searched so as to maximize the benefits achieved by CCHP system in comparison to SP. When the optimal criterion is satisfied, the binary codes are decoded into decimalization and the optimal capacity and operation strategy of CCHP system in consideration of the annual operation are determined. Otherwise, the best individual is selected, the initial population is operated through reproduction, crossover and mutation, and then the search is turned back to the fitness calculation again until the optimal criterion is satisfied.

**Table 1**

Input values employed for the energy used calculations for CCHP system and separation production system.

System	Variable	Symbol	Mean value
PGU of CCHP system	Efficiency	$\eta_e$	0.3
Waste heat recovery system	Efficiency	$\eta_{rec}$	0.8
Electric chiller	COP	$COP_e$	3
Absorption chiller	COP	$COP_{ch}$	0.7
Boiler	Efficiency	$\eta_b$	0.8
Heating coil	Efficiency	$\eta_h$	0.8
PGU of separation production system	Efficiency	$\eta_e^{SP}$	0.35
Grid	Transmission efficiency	$\eta_{grid}$	0.92
CO <sub>2</sub> emission conversion factor (g/kWh)	Natural gas	$\mu_{CO_2,f}$	220
	Electricity from grid	$\mu_{CO_2,e}$	968

**Table 2**

Unit price of the facilities.

Facility	Prime mover	Heating coil	Boiler	Absorption chiller	Electric chiller
Unit price (Yuan/kW)	6800	200	300	1200	970

**Table 3**

Unit price of electricity and natural gas.

	Natural gas	Electricity (6:00–21:00)	Electricity (22:00–5:00)
Unit price (Yuan/kWh)	0.194	0.964	0.435

**Table 4**

GA parameters.

Variable	Value
Population size	80
Evolutionary generations	100
Crossover probability	0.60
Length of genes	10
Mutation probability	0.10
Weights( $\omega_1 = \omega_2 = \omega_3$ )	1/3
<b>Search range</b>	
Capacity	[0,1000]
Ratio of electric cooling to cool load	[0,1]

## 4. Application

### 4.1. Building description and energy demands

To apply GA optimization method to determine the capacity of CCHP system and the ratio of electric cooling to cool load, the baseline building under consideration is a hypothetical hotel building in Beijing. The hotel has a floor area of 9400 m<sup>2</sup> and an average main ceiling height of 3.6 m. The total area of the windows and glazing comprises about 30% of the total wall area. The building includes the guest rooms, office rooms, dining halls, ballrooms and divans. The building operates during the entire year. The temperature setpoint of guest room is 22–24 °C. The hourly energy load of the building is estimated using the software DeST [39], which is inputted to calculate the fitness in Fig. 2. Fig. 4 shows the annual daily cooling, heating and power loads of the hotel. From these profiles, the following characteristics can be derived:

- (1) The daily electricity demand is stable relatively and is generally less than the heat and cool load;
- (2) the daily heat load and cool load both fluctuate more than the daily electricity demand;
- (3) the cool load peak is greater than the heat load peak because of the hot climate of Beijing;
- (4) in spring and autumn, the energy demands for cooling, heating and power are close.

### 4.2. Optimization calculation

The characteristic parameters of CCHP system and SP system are listed in Tables 1–3, which are used to calculate the fitness in Fig. 2. GA parameters are shown in Table 4. Then the variables are optimized by GA programming in Fig. 2. During the search, the genetic operators are important to the GA optimal process

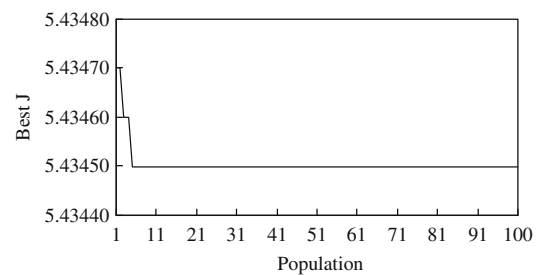

**Fig. 5.** Optimization process of objective function in GA.

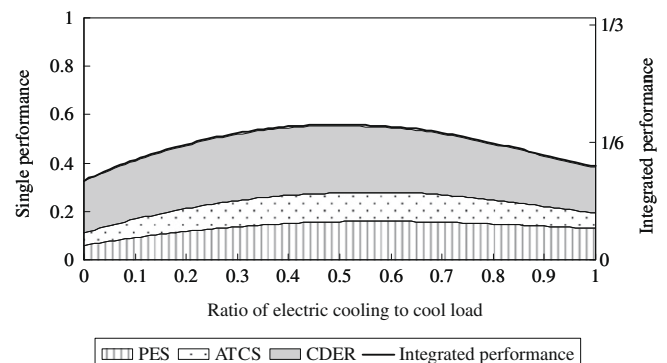

**Fig. 6.** PES, ATCS, CDER and the integrated performance of CCHP system for various ratio of electric cooling to cool load.

and the calculation convergence. The reproduction adopts the proportional selection method. In order to preserve the feasibility of offspring generated by crossover, we use the basic one-point crossover. The mutation operators are usually used in order to keep the diversity of individuals, and the mutation of bit-reverse type is adopted in this paper, which replaces a gene with its allele. Finally, the optimal values of capacity of PGU and ratio of electric cooling to cool load are searched by GA as follows:

$$F_{\max} = 525 \text{ kW}$$

and

$$x = 0.53$$

The two optimal parameters show that the maximum input fuel, the capacity of PGU of CCHP system is 525 kW (in this paper, it is assumed that the optimal capacity is just equal to the capacity of PGU), and 53% of cool load of building is provided by electric chiller and the remaining cool is provided by absorption chiller in heat from recovery system or supplementary boiler. The optimal process of objective function in Eq. (24) is shown in Fig. 5. It can be found that the objective value remains unchanged after reproducing only five populations, which shows that the search speed of GA is fast. Although other optimization methods can also search the optimal solutions, the methods have their own disadvantages. For example the simplex method is sensitive to the initial values and the search is easy to get in the local optimization solution. Compared to other methods, GA is a valid search method that needs no initial information and searches the global optimization solution. GA operates parallel from multi-points, and searches heuristically in the solution area. Consequently, GA overcomes the search blindness and the search speed of GA is faster than the simplex method. If the initial values are selected appropriately, the search speed will be faster.

After determining the two optimal values, one of the two parameters is kept constant and another is an exogenous variable that varies within the some ranges. The PES, ATCS, CDER and the integrated performance of CCHP system in comparison to SP are calculated again and shown in Figs. 6 and 7, respectively.

Fig. 6 shows the performance areas of CCHP system with the various ratios of electric cooling to cool load when capacity is equal to 525 kW. It can be seen that the integrated performance, the top thick black line, is vaulted curve and always positive. The integrated performance increases firstly, then the increasing speed becomes slow gradually and reaches the peak, 18.40%, with the increasing of ratio of electric cooling to cool load when the capacity is less than 0.53. When the ratio of electric cooling to cool load is greater than 0.53, the integrated performance begins to decrease. Similar to the integrated performance, it is found that the three performances, PES, ATCS and CDER are also vaulted curves with the increasing of ratio of electric cooling to cool load. The CDER po-

tential of CCHP system in comparison to SP is the most outstanding. The proportion of ATCS to the integrated performance is the least. The points shows that the CCHP after optimization of design and operation can obtain better performances to save primary energy, decrease cost and reduce CDE than the SP. Especially, CCHP system is a environment-friendly plant to reduce CDE.

Fig. 7 shows the performance areas of CCHP system with the various capacities when ratio of electric cooling to cool load is equal to 0.53. The weighted integrated performance of CCHP system is shown in the top thick line. It increases in greater speed, then slows the increasing speed and reaches the maximum value, 18.40%, at 525 kW, and finally decreases gradually with the increasing of capacity of PGU. Additionally, it can be noted that all single performances and the integrated performance are negative when the capacity is less than 84 kW. The reason is that the parasitic electric energy consumption of CCHP system is more than that of the SP. When the capacity is little, the benefits from CCHP system cannot offset the greater parasitic energy consumption. Therefore, whether the micro-CCHP system with small capacity is better than the SP is considered in future works.

Similarly, the components of the integrated performance are analyzed. It can be seen that both of PES and CDER increase firstly, reach the peak, and then decrease with the increasing of the capacity of PGU. However, the later decreasing scope is very little until they remain unchanged, which is mainly determined by the heat demand of building. When the CCHP system operates following the thermal load, and the heat demand of building is fixed and satisfied, the increasing of capacity is meaningless so that the PES and CDER won't change with the capacity.

The trend of ATCS increases firstly, reaches the maximum value, and then decreases with the increasing of the capacity of CCHP system. However, its decreasing speed is more obvious than PES's and

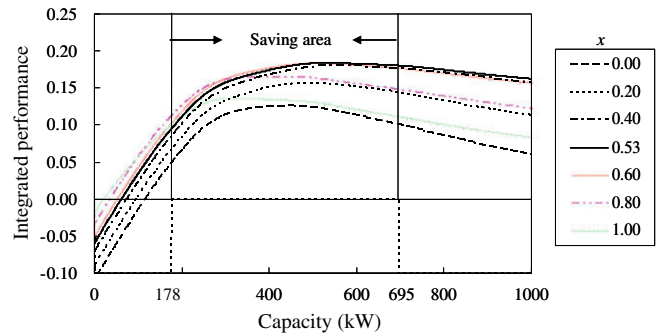

Fig. 8. The integrated performance of CCHP system for various capacities and ratio of electric cooling to cool load.

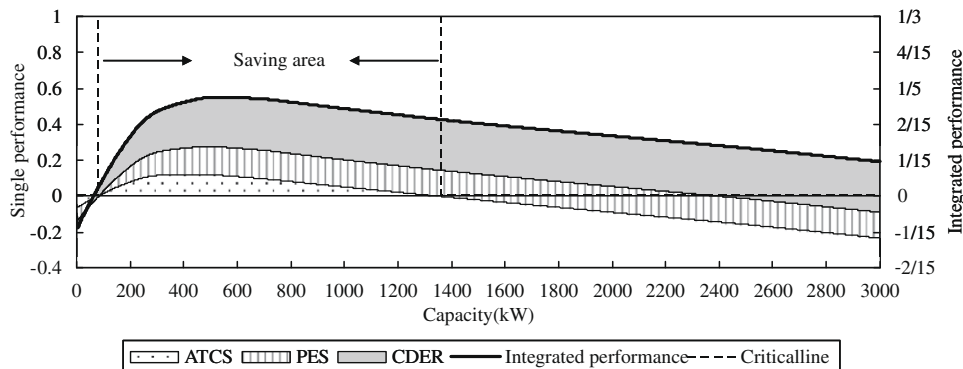

Fig. 7. PES, ATCS, CDER and the integrated performance of CCHP system for various capacities.

CDER's. When the capacity is more than about 1350 kW, the CCHP system won't save the annual cost because of the excessive capital cost. Although CCHP system still save the primary energy in comparison to the SP, it can not reach the goal of saving the cost for

users. Therefore, the area between 84 kW and 1350 kW is called saving area. The results indicate that the selection of capacity of CCHP system in design stage is important to its performance. Only the CCHP system that yields economical savings, energy savings

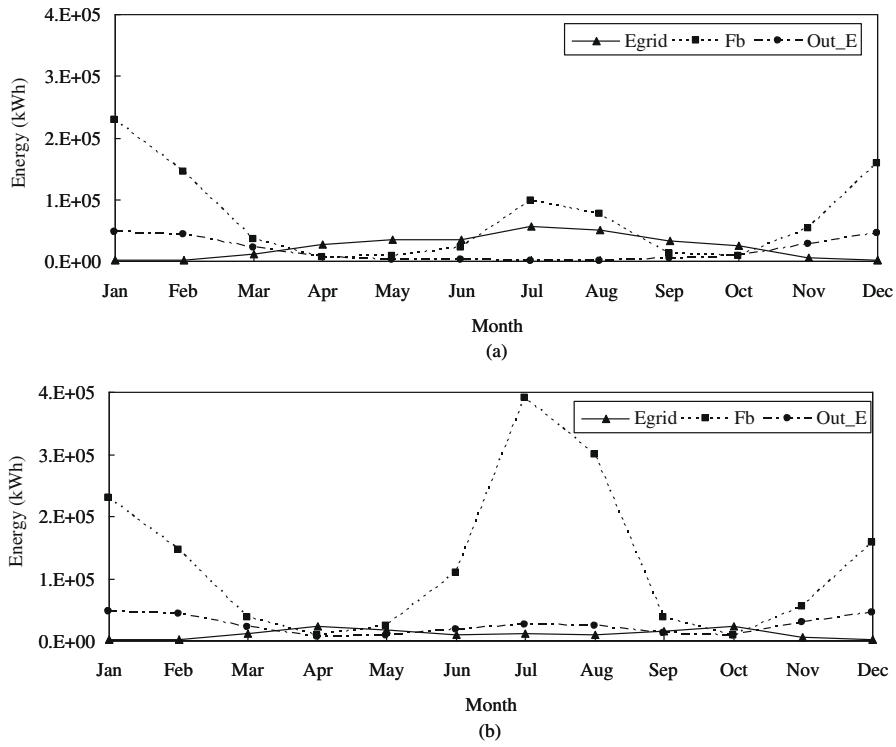

Fig. 9. Monthly electricity from grid, supplementary heat and excess electricity of CCHP systems. (a) Case 1, optimal CCHP system; (b) case 2, CCHP system that only adopts absorption chiller.

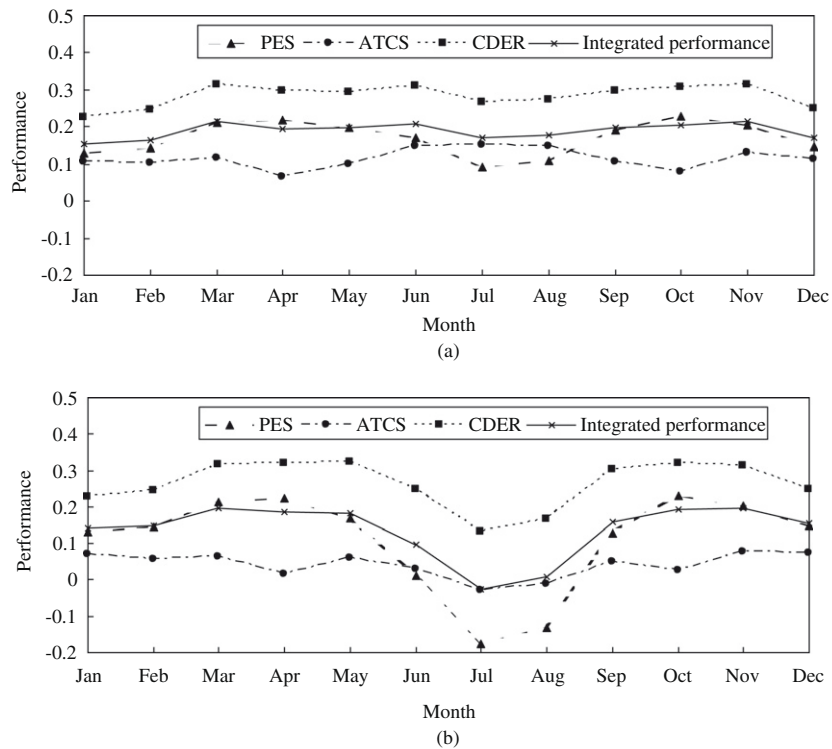

Fig. 10. Monthly PES, ATCS, and CDER variation of CCHP systems for the hotel. (a) Case 1, optimal CCHP system; (b) case 2, CCHP system that only adopts absorption chiller.

as well as reducing the emission of pollutants is a good CCHP system.

To verify the validity of GA optimization in CCHP system, the integrated performances of CCHP system that simultaneously vary with the capacity and ratio of electric cooling to cool load are calculated and shown in Fig. 8. It can be found that the integrated performance of CCHP system increases with the increasing of ratio of electric cooling to cool load at the small capacity. In the middle, the increasing speed with ratio are different and when the ratio is

greater than the optimal ratio, 0.53, the integrated performance begins to decrease with the increasing of ratio of electric cooling to cool load. From these curves, it can be seen that the integrated performance at the optimal point is the maximum, which indicates the effectiveness of GA optimization method. Then the saving area is searched again and it locates the interval between 178 kW and 695 kW.

5. Analysis and discussion

Adopted the optimal capacity and ratio of electric cooling to cool load, the monthly performance of CCHP system providing cool, heat and electricity to the hotel in Beijing is analyzed. The optimal CCHP system is called Case 1. An additional CCHP system, Case 2, where cooling system adopts only absorption chiller and  $x = 0$ , is selected to compare the performance of optimal CCHP system. Other parameters are same as the optimal CCHP system's and the operations follow the thermal demand.

The monthly electricity from grid, supplementary heat and excess electricity of CCHP systems for the hotel are shown in Fig. 9. The top figure is the optimal CCHP system's characteristic and another is the characteristic of Case 2. It can be found that

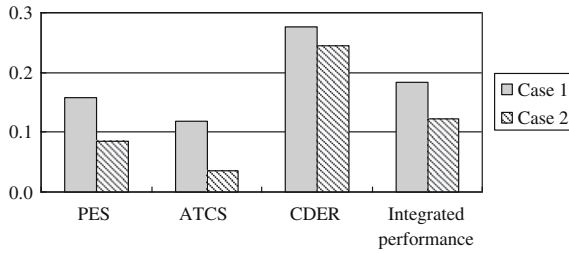

Fig. 11. Comparison of annual PES, ATCS, CDER and integrated performance of CCHP systems.

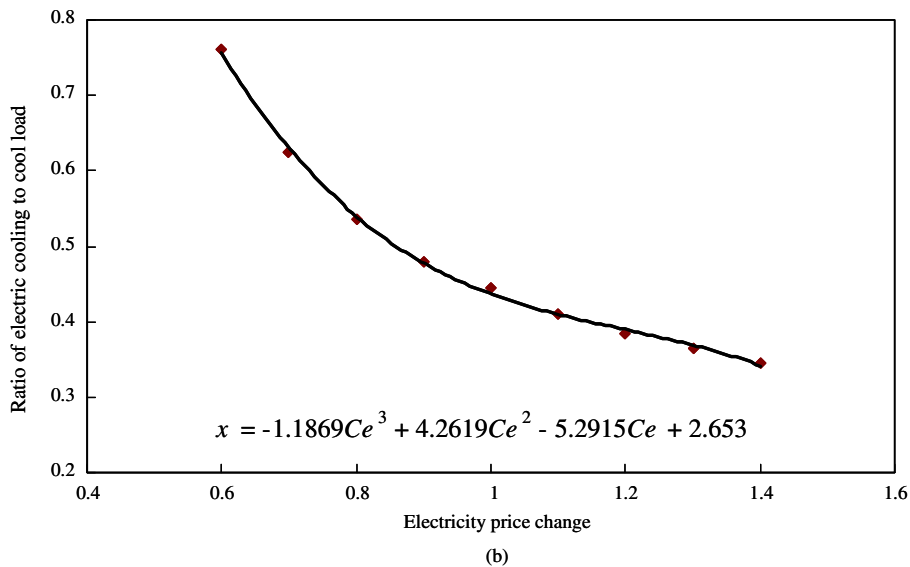
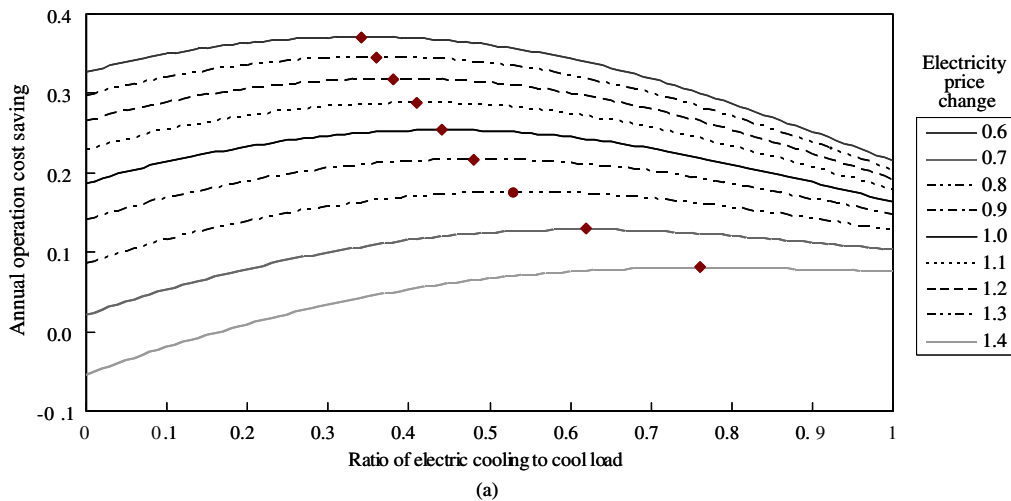

Fig. 12. Electricity price sensitivity.



the supplementary heat from boiler,  $F_b$ , in Case 2, is much more than the optimal CCHP system in summer while the electricity from grid is just inverse. Additionally, the excess electricity is produced by Case 2, and it is not allowed to sell back grid so that the additional energy is exhausted. While the optimal CCHP system adopts mix chiller, the excess electricity is used to produce cool by electric chiller. Therefore, there is almost no export electricity, Out\_E in Fig. 9, of the optimal CCHP system in summer, which saves the primary energy.

Then the performances of CCHP systems are both calculated and shown in Fig. 10. Fig. 10a and b show the characteristic of Case 1 and Case 2 respectively. It is known that the difference is only in the seasons when the building needs cool. The trends of PES and CDER of the two CCHP systems are similar except the ATCS. In summer, the primary energy consumption of the optimal CCHP system decreases greatly because of the excess electricity is provided to produce cool. Consequently, the annual cost and the CDE of CCHP system are also reduced. The CCHP system that only employs absorption chiller cannot save primary energy in summer because of the excess electricity is exhausted. If there are means to recover or store the excess electricity, the performance of Case 2 will be improved. As a result, the utilization of the excess electricity produced by CCHP system following thermal demand is paid

more attention. In addition, the monthly integrated performance of the optimal CCHP system is more stable than Case 2. The monthly integrated performance of Case 2 decreases greatly in summer. Consequently, the buildings needing more cool are paid more attention and optimized.

The annual PES, ATCS, CDER and integrated performance of two cases is show in Fig. 11. It can be seen that CDER of CCHP system occupies the first place in the three aspects, PES follows and ATCS is the last. However, the economical difference of two CCHP systems is the most, and PES and CDER follow. The annual integrated performance of the optimal CCHP system is 6.2% greater than that of the Case 2.

5.1. Sensitivity analysis

After the optimal design of CCHP system for the building, the equipments are selected and their capacities remain unchanged. But the ratio of electric cooling to cool load varies in some ranges as long as the outputs of equipment are less than their capacities. Additionally, the prices of electricity from grid and natural gas determine the operation cost of CCHP system.

This section studies the ideal relationship between operation cost and the ratio of electric cooling to cool load. Herein, the

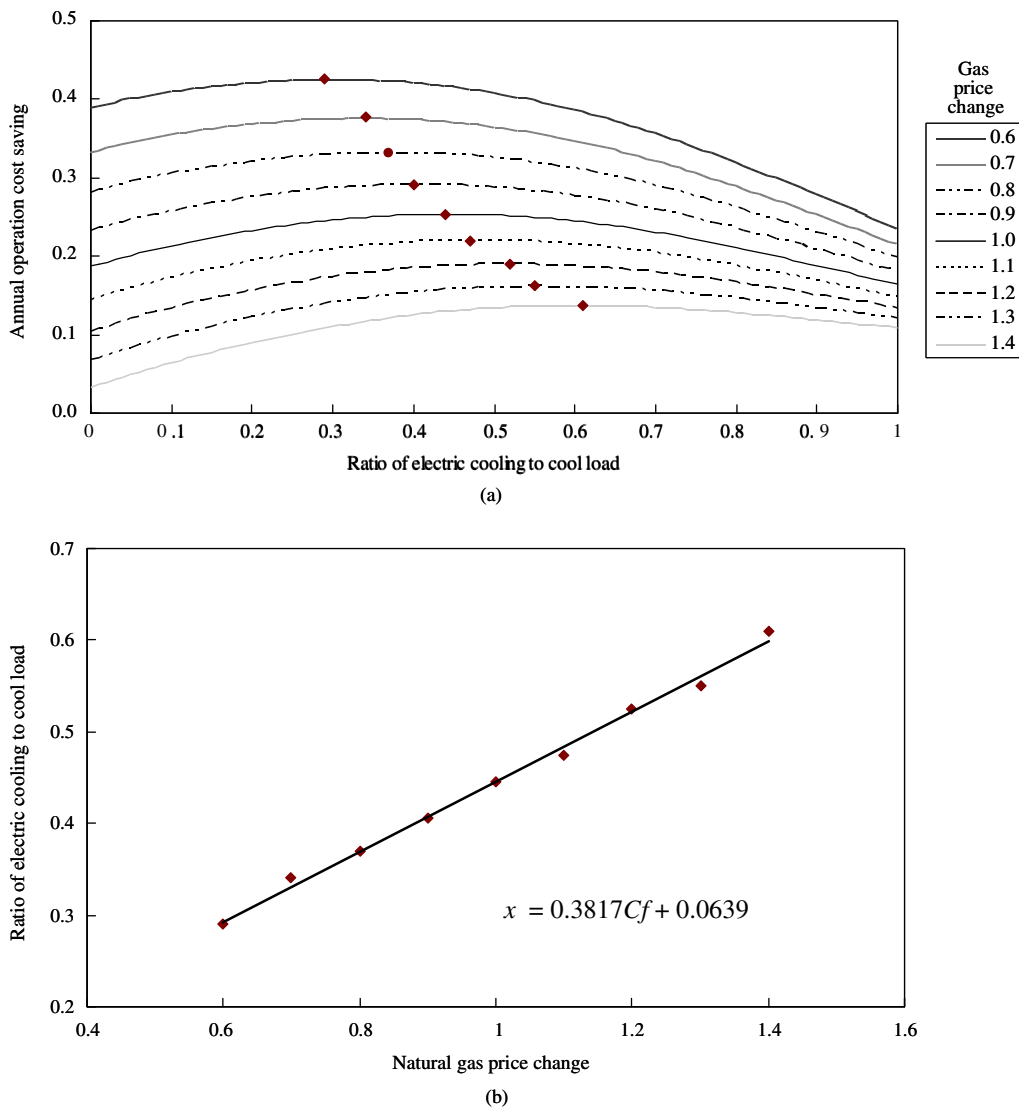

Fig. 13. Natural gas price sensitivity.

operation cost doesn't include the maintenance cost. The operation cost of CCHP system is determined by the electricity consumption from grid and the on-site natural gas consumption, and their prices. When the operation strategy of CCHP system is designed, only operation cost fluctuates with the changes of electricity price and gas price. Similarly, annual operation cost saving of CCHP system in comparison to the SP is defined to analyze the sensitivity. Its definition is same as ATCS in Eq. (20), and the difference is that the capital cost in Eq. (18) is not included. All calculations are based on the design parameters in Section 4.

#### 5.1.1. Electricity price sensitivity analysis

In the optimal design, the electricity prices in Table 3 are selected to determine the optimal economical performance, which is as the baseline of electricity price. Then the electricity increases or decreases 10%, 20%, 30% and 40%, respectively. The changes of the annual operation cost saving with various ratios of electricity cooling to cool load and electricity prices are displayed in Fig. 12a. It can be found that the area between increasing 40% and decreasing 40% presents a horn shape, the left is wider and the right part is narrower. The maximum annual operation cost savings in each electricity price are marked as shown the thick points in Fig. 12a. It is known that the optimal ratio of electric cooling to cool load decreases when the electricity price increases. When the electricity price increases, the ratio of electric cooling to cool load is decreased to minimize the operation cost. Then these optimal points are selected and Fig. 12b is constructed. The points are fitted to the curve and the fitting function between the ratio electric cooling to cool load,  $x$ , and the increasing of the electricity,  $C_e$ , is expressed as follows:

$$x = -1.1869C_e^3 + 4.2619C_e^2 - 5.2915C_e + 2.6530 \quad (25)$$

The function will guide the operation strategy and determine the ratio of electric cooling to cool load when the electricity price from grid increases or decreases.

#### 5.1.2. Natural gas price sensitivity analysis

Similarly, the sensitivity analysis of gas price is shown in Fig. 13a. The shape is similar to the electricity price sensitivity. However, it is seen that the relationship between annual operation cost saving and gas price is contrary to the electricity price and they are proportional. When the gas price increases, the ratio of electric cooling to cool load is increased to achieve more benefits from CCHP system in comparison to SP. In the same way, the optimal annual operation cost savings are selected to form to Fig. 13b. The fitting linear function is written to:

$$x = 0.3817C_f + 0.0639 \quad (26)$$

where  $C_f$  is the cost of natural gas.

Compared to the non-linear function in Eq. (25), the ratio of electric cooling to cool load is less sensitive to the gas price. Therefore, when the price of electricity from grid is changed and the ratio of electric cooling to cool load is paid more attention.

## 6. Conclusion

GA has been employed to optimize the capacity and operation strategy of CCHP system on the basis of energy flow. Optimal values of equipment capacities have been determined in considering operational strategy. Through a numerical example of CCHP system for a hotel building in Beijing, the effectiveness of the proposed method has been demonstrated. The optimal analysis in this paper leads to the following conclusions:

The integrated performance of CCHP system increases firstly, then the increasing speed becomes slow gradually and reaches

the peak, and finally decreases with the increasing of the capacity and the ratio of electric cooling to cool load, respectively. The PES and CDER of CCHP system in comparison to SP system finally keep the limited value, while the ATCS will decrease all along with the capacity and ratio.

The CCHP system for the building that demands more heat or cool than electricity operates following the thermal demand and the excess electricity is usually produced. The mixed cooling system is adopted to reduce the exhaust of excess electricity. The optimal ratio of electric cooling to cool load is helpful to improve the integrated performances of CCHP system from technology, economy and environment in summer.

When the price of the electricity from grid or natural gas increases, the design value of the ratio of electric cooling to cool load can decrease or increase respectively as long as the outputs of equipments are less than their capacities. The impact of the optimal ratio by the change of electricity price is greater than that of the gas price.

Although the optimization of design and operation strategy is based on the energy demands of a specific building, and there are some assumptions such as the exhaust of the excess electricity, the optimal method can be applied in CCHP systems with different prime movers for different buildings. It is believed that if this procedure is applied correctly and in combination with other elements, such as energy analysis of buildings and the running efficiency of equipments, it can become a powerful and effective tool for the fundamental design of CCHP systems.

## Acknowledgements

This research has been supported by North China Electric Power University Fund (No.200914006) and the Key Laboratory of Condition Monitoring and Control for Power Plant Equipment of Ministry of Education, China.

The authors also wish to express their gratitude to the anonymous referees for remarks and suggestions that improved this paper significantly.

## References

- [1] Wu DW, Wang RZ. Combined cooling, heating and power: a review. *Prog Energy Combust Sci* 2006;32(5–6):459–95.
- [2] Chicco G, Mancarella P. Distributed multi-generation: a comprehensive view. *Renew Sustain Energy Rev* 2009;13(3):535–51.
- [3] Joel HS, Augusto SC. Trigeneration: an alternative for energy savings. *Appl Energy* 2003;76(1–3):219–27.
- [4] Wang JJ, Jing YY, Zhang CF, Zhang XT, Shi GH. Integrated evaluation of distributed triple-generation systems using improved grey incidence approach. *Energy* 2008;33(9):1427–37.
- [5] Wang JJ, Jing YY, Zhang CF, Shi GH, Zhang XT. A fuzzy multi-criteria decision-making model for trigeneration system. *Energy Policy* 2008;36(10):3823–32.
- [6] Medrano M, Brouwer J, McDonell V, Mauzey J, Samuelsen S. Integration of distributed generation systems into generic types of commercial buildings in California. *Energy Build* 2008;40(4):537–48.
- [7] Kong XQ, Wang RZ, Huang XH. Energy optimization model for a CCHP system with available gas turbines. *Appl Therm Eng* 2005;25(2–3):377–91.
- [8] Sepehr S, Masoud Z, Maziar G. Optimal design of gas turbine CHP plant with preheater and HRSG. *Int J Energy Res* 2009;33(8):766–77.
- [9] Zhang B, Long W. An optimal sizing method for cogeneration plants. *Energy Build* 2006;38(3):189–95.
- [10] Savola T, Tveit TM, Fogelholm CJ. A MINLP model including the pressure levels and multiperiods for CHP process optimisation. *Appl Therm Eng* 2007;27(11–12):1857–67.
- [11] Dai Y, Wang J, Gao L. Exergy analysis, parametric analysis and optimization for a novel combined power and ejector refrigeration cycle. *Appl Therm Eng* 2009;29(10):1983–90.
- [12] Kong XQ, Wang RZ, Li Y, Huang XH. Optimal operation of a micro-combined cooling, heating and power system driven by a gas engine. *Energy Convers Manage* 2009;50(3):530–8.
- [13] Cardona E, Piacentino A. Optimal design of CHCP plants in the civil sector by thermoeconomics. *Appl Energy* 2007;84(7–8):729–48.
- [14] Savola T, Fogelholm CJ. MINLP optimisation model for increased power production in small-scale CHP plants. *Appl Therm Eng* 2007;27(1):89–99.

- [15] Arcuri P, Florio G, Fragiaco P. A mixed integer programming model for optimal design of trigeneration in a hospital complex. *Energy* 2007;32(8):1430–47.
- [16] Thorin E, Brand H, Weber C. Long-term optimization of cogeneration systems in a competitive market environment. *Appl Energy* 2005;81(2):152–69.
- [17] Rong A, Lahdelma R. An efficient linear programming model and optimization algorithm for trigeneration. *Appl Energy* 2005;82(1):40–63.
- [18] Rong A, Hakonen H, Lahdelma R. An efficient linear model and optimisation algorithm for multi-site combined heat and power production. *Eur J Oper Res* 2006;168(2):612–32.
- [19] Piacentino A, Cardona F. EABOT – Energetic analysis as a basis for robust optimization of trigeneration systems by linear programming. *Energy Convers Manage* 2008;49(11):3006–16.
- [20] Ren H, Gao W, Ruan Y. Optimal sizing for residential CHP system. *Appl Therm Eng* 2008;28(5–6):514–23.
- [21] Li CZ, Shi YM, Huang XH. Sensitivity analysis of energy demands on performance of CCHP system. *Energy Convers Manage* 2008;49(12):3491–7.
- [22] Rong A, Lahdelma R, Luh PB. Lagrangian relaxation based algorithm for trigeneration planning with storages. *Eur J Oper Res* 2008;188(1):240–57.
- [23] Sakawa M, Kato K, Ushiro S. Operational planning of district heating and cooling plants through genetic algorithms for mixed 0–1 linear programming. *Eur J Oper Res* 2002;137(3):677–87.
- [24] Weber C, Maréchal F, Favrat D, Kraines S. Optimization of an SOFC-based decentralized polygeneration system for providing energy services in an office-building in Tokyo. *Appl Therm Eng* 2006;26(13):1409–19.
- [25] Piacentino A, Cardona F. On thermoeconomics of energy systems at variable load conditions: integrated optimization of plant design and operation. *Energy Convers Manage* 2007;48(8):2341–55.
- [26] Cho H, Luck R, Eksioğlu SD, Chamra LM. Cost-optimized real-time operation of CHP systems. *Energy Build* 2009;41(4):445–51.
- [27] Cao JC, Liu FQ. Simulation and optimization of the performance in the air-conditioning season of a BCHP system in China. *Energy Build* 2008;40(3):185–92.
- [28] Cardona E, Piacentino A. A methodology for sizing a trigeneration plant in mediterranean areas. *Appl Therm Eng* 2003;23(13):1665–80.
- [29] Chicco G, Mancarella P. Assessment of the greenhouse gas emissions from cogeneration and trigeneration systems. Part I: models and indicators. *Energy* 2008;33(3):410–7.
- [30] Mago PJ, Fumo N, Chamra LM. Performance analysis of CCHP and CHP systems operating following the thermal and electric load. *Int J Energy Res* 2009;33(9):852–64.
- [31] Almeida FS, Awruch AM. Design optimization of composite laminated structures using genetic algorithms and finite element analysis. *Compos Struct* 2009;88(3):443–54.
- [32] Guo J, Xu M, Cheng L. The application of field synergy number in shell-and-tube heat exchanger optimization design. *Appl Energy* 2009;86(10):2079–87.
- [33] Luo X, Wen QY, Fieg G. A hybrid genetic algorithm for synthesis of heat exchanger networks. *Comput Chem Eng* 2009;33(6):1169–81.
- [34] Matta ME. A genetic algorithm for the proportionate multiprocessor open shop. *Comput Oper Res* 2009;36(9):2601–18.
- [35] Ooka R, Komamura K. Optimal design method for building energy systems using genetic algorithms. *Build Environ* 2009;44(7):1538–44.
- [36] Pasdarpour M, Ghazavi M, Teshnehlab M, Sadrnejad SA. Optimal design of soil dynamic compaction using genetic algorithm and fuzzy system. *Soil Dyn Earthquake Eng* 2009;29(7):1103–12.
- [37] Sayyaadi H, Sabzaligol T. Various approaches in optimization of a typical pressurized water reactor power plant. *Appl Energy* 2009;86(7–8):1301–10.
- [38] Wang JJ, Jing YY, Zhang CF. Genetic optimization algorithm on PID decoupling controller for variable flow heating system. In: *Proceeding of the 3rd IEEE conference on industrial electronics and applications*; 2008. p. 510–15.
- [39] DeST development group in Tsinghua University. *Building environmental system simulation and analysis-DeST*. Beijing: China Architecture & Building Press; 2006.