

SOURCE VOLTAGE, FREQUENCY AND IMPEDANCE VARIATION EFFECTS ON THE HARMONICS GENERATED FROM A PERSONAL COMPUTER

M. J. H. Rawa

D.W.P. Thomas

M. Sumner

J.X. Chin

*Electrical Systems and Optics Research Division, The University of Nottingham, UK
mrawa@kau.edu.sa; dave.thomas@nottingham.ac.uk; mark.sumner@nottingham.ac.uk; jx.chin@family.ust.hk*

Keywords: Harmonics, Distortion, Forward Converter, PFC.

Abstract

The penetration of harmonics in residential power system networks due to the widespread use of nonlinear loads such as Personal Computers (PCs) can cause severe problems including voltage and current distortion. Almost all residential customers are subjected to variations in the system voltage and frequency. Also, the source impedance is different for different customers depending on their distance from the utility transformers and distribution cabinets and the system loading. Hence, the purpose of this paper is to investigate the effects of the voltage amplitude, source impedance and system frequency on the harmonics produced by a single PC for variations within practical limits. Experimental measurements and computer simulations are performed to confirm the observations.

1 Introduction

Recently, residential customer's input voltages are becoming more distorted due to the widespread use of nonlinear loads such as Personal Computers (PCs). It has been estimated that by 2012, 60% of the loads on power system in USA will be nonlinear loads [1]. The penetration of harmonics in residential power system networks can cause severe problems such as decrease in power factor, increase in voltage distortion, increased interference with communications networks, impact energy metering, increase system losses and decrease the overall system efficiency [2-7].

Almost all residential customers are subjected to variations in the source voltage and system frequency. Moreover, the source impedance is different for different customers depending on their distance from the utility transformers and distribution cabinets and the system loading. Therefore, this paper aims to assess the effects of voltage magnitude, source impedance and system frequency variations on the harmonics generated by a single PC. The study is performed on a PC as it is generally considered to be the most significant SMPS based nonlinear load, because of its high power rating (a typical PC consumes 200–300 W) and a large number of PCs can be connected simultaneously to a single power supply as in the case of commercial buildings [8].

Due to the low source impedance and low current drawn by a single PC, the voltage distortion is too small to be considered and changes due to any of the parameter variation are almost negligible. Therefore, this harmonics study will be focused on the current distortion that will be quantified using Total Harmonic Distortion (THD) index as well as Individual Harmonic Distortion (IHD) up to the 11th order harmonic. Power factor, active, nonactive and apparent power are also considered [9].

2 Test rig and load modelling

To quantify to what extent these variations affect the generated harmonics, practical laboratory measurements and computer simulations based on Matlab Simulink [10] are carried on a 420W PC (117W at system idle mode) to monitor the THD and individual harmonics produced by the PC for different system conditions. The measurements were repeated 27 times, for 3 different voltage levels (227V, 240V and 253V), 3 different source impedances (0.15 Ω , 0.25 Ω and 0.35 Ω) and 3 different system frequency values (49.5Hz, 50 Hz and 50.5 Hz). These variations are within the permissible limits according to BS 7671, for National Grid and Central Networks in the UK [11-13].

The input voltage magnitude, frequency and source impedance were controlled using a programmable AC source ChromaTM 61511 [14]. It also helps in isolating the test rig and filtering out harmonics and fluctuations from the main power supply. Both input voltage and current of the PC were monitored using a KinetiQ PPA1530 Power Analyzer [15]. Other quantities such as power factor, active, nonactive and apparent power are also monitored. More details about specifications the Chroma, KinetiQ Power Analyzer and PC under test can be found in Appendix A. Figure 1 shows the test rig used for the measurement.

Similarly, the simulations were repeated 27 times for the same cases obtained by the measurements. The PC is modelled accurately using a typical two-switch forward converter configuration shown in Fig. 2 [16]. In this research work, a flyback converter of a 117 W/12V will be simulated with an output voltage ripple factor of 1% and a typical switching frequency of 100 kHz.

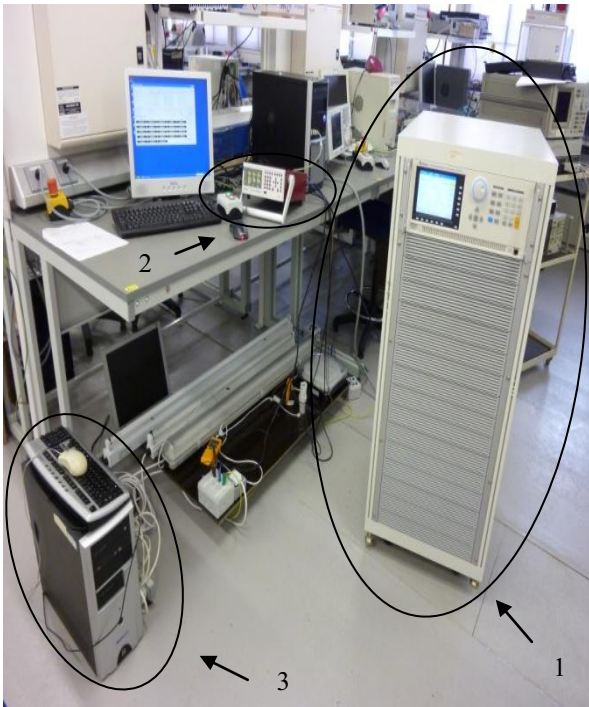

Fig. 1 Test rig. (1) Chroma power supply. (2) KineticQ power analyzer. (3) DUT.

3 Harmonics quantification and results

Due to the huge data that cannot be presented within the permissible limit of the paper, part of the measurement are considered in which one variable was changed at a time while the other two variables were kept constant at the nominal values. 240V, 50Hz and 0.25Ω were set to be the nominal values for the system voltage, frequency and impedance, respectively.

Hence, three cases were considered in this paper and the input values for the three parameters are:

- Case 1: V_{in} = 1) 227V 2) 240V 3) 253V, f =50Hz and $|Z_s|=0.25 \Omega$.
- Case 2: f = 1) 49.5 Hz 2) 50 Hz 3) 50.5 Hz, V_{in} =240V and $|Z_s|=0.25 \Omega$.
- Case 3: $|Z_s|$ = 1) 0.15 Ω 2) 0.25 Ω 3) 0.35 Ω , V_{in} =240V and f =50Hz.

3.1 Voltage variation

In this case the source voltage has been changed to be 227V, 240V and 253V. The system frequency is 50Hz and the source impedance is 0.25Ω. Fig. 3 shows the measured and simulated THDi values for the three different cases. It can be seen from the measurement that increasing the input voltage from 240V to 253V increases the current distortion by 3.13% while decreasing the voltage from 240V to 227V decreases the current distortion by 4.34%. Similarly, simulation results show a 2.25% increase in THDi resulting from the voltage increase from 240V to 253V, while decreasing the voltage down to 227V from 240V decreases THDi by about 2.57%. Fig. 3 also shows that simulation and measurement give almost same THDi values.

In general, due to power control, increasing the system voltage causes a PC to draw less current for the same input power. This means that the current becomes more distorted. Therefore, the lower the input voltage, the more the input current and the less current distortion.

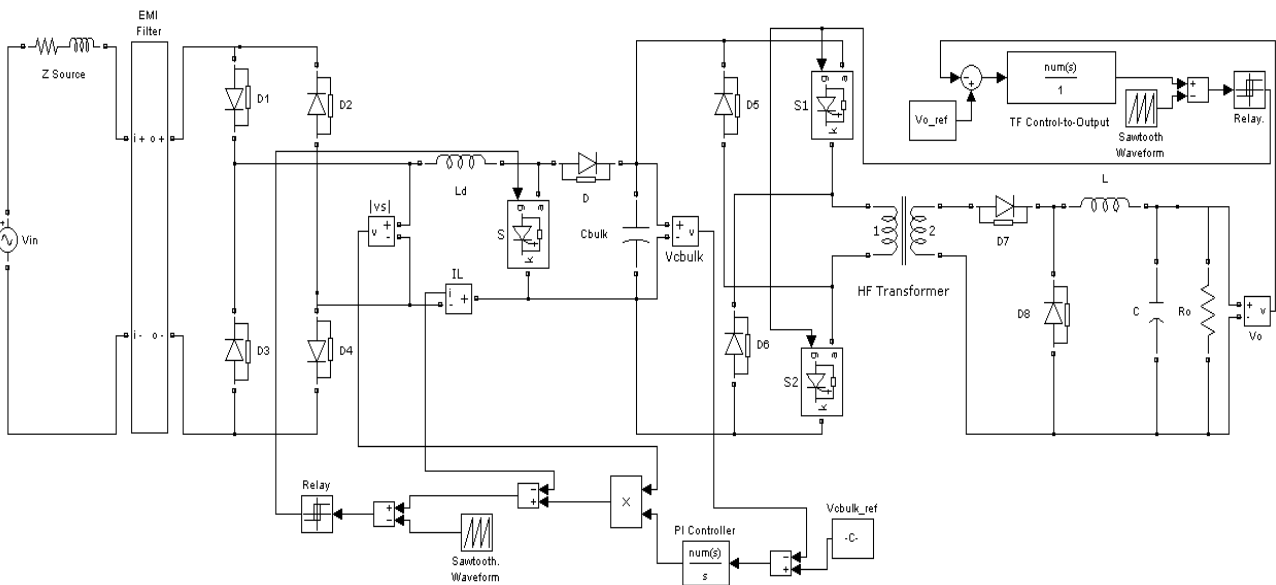

Fig. 2 SMPS with a two-switch forward converter

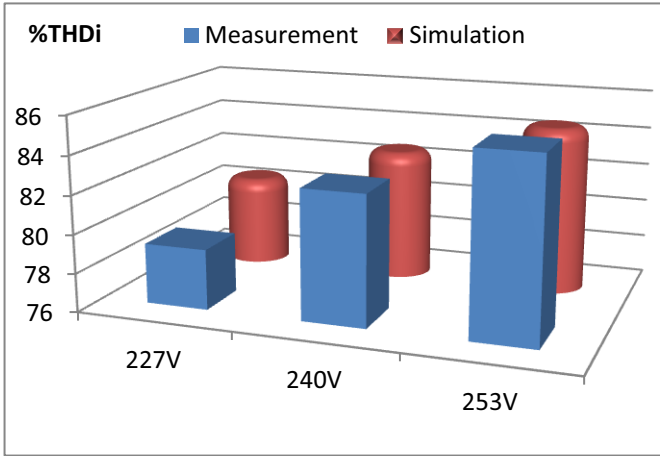

Fig. 3 THD due to voltage variation

Figures 4 and 5 illustrate that all individual current harmonic indices resulting from measurement and simulation increase with increasing the source voltage, except the measured 7th order harmonic that decreases with increasing the source voltage.

3.2 Impedance variation

It can be seen from Fig. 6 that source impedance within the allowed limits have small effects on the harmonics generated from the PC and current distortion tends to decrease with increasing source impedance.

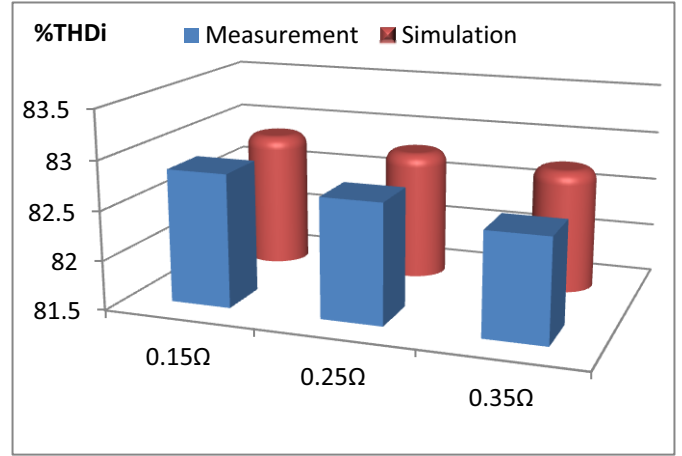

Fig. 6 THD due to impedance variation

This phenomenon can be best described by referring to equation 1 [3]. Harmonic voltage distortion is directly proportional to the percentage source impedance; while the harmonic current distortion is inversely proportional with the source impedance. Hence, increasing the source impedance decreases THDi.

$$\%V_h = h \frac{I_h/I_1}{I_{sc}/I_1} \times 100 = h \times \frac{I_h}{I_1} \times \%|Z_s| \quad (1)$$

It can also be seen in Fig. 7 that increasing the source impedance increases the 3rd, 5th, 9th and 11th order harmonics while decreases the 7th order harmonic. Simulation results are close to the measurement but show almost no change with the slight change in the source impedance magnitude as seen in Fig. 8.

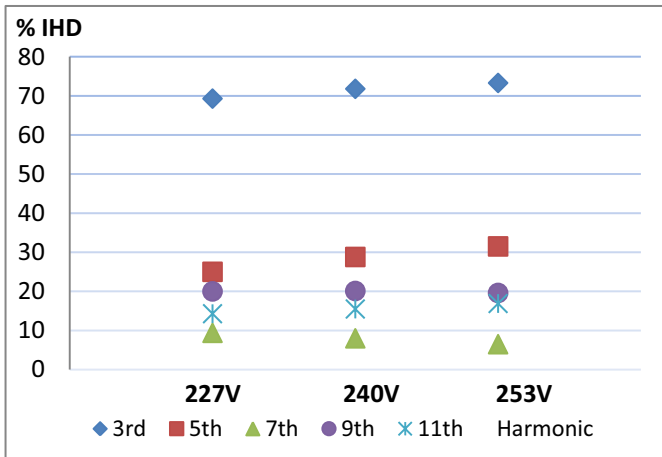

Fig. 4 Individual harmonics due to voltage variation (Measurement)

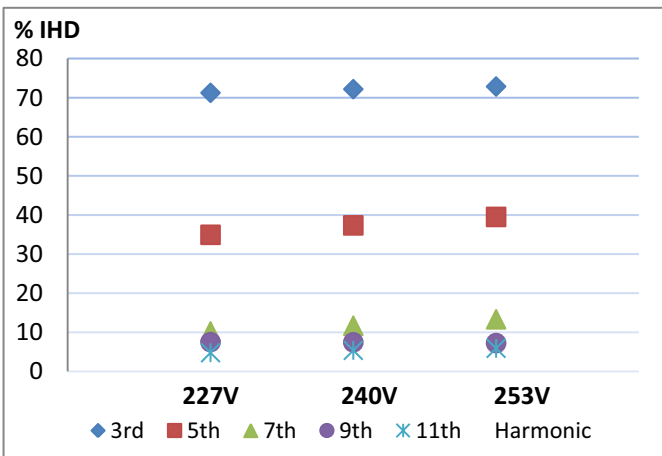

Fig. 5 Individual harmonics due to voltage variation (Simulation)

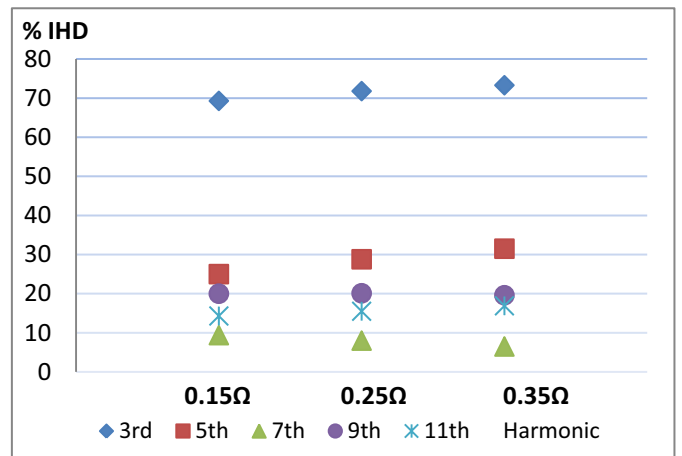

Fig. 7 Individual harmonics due to impedance variation (Measurement)

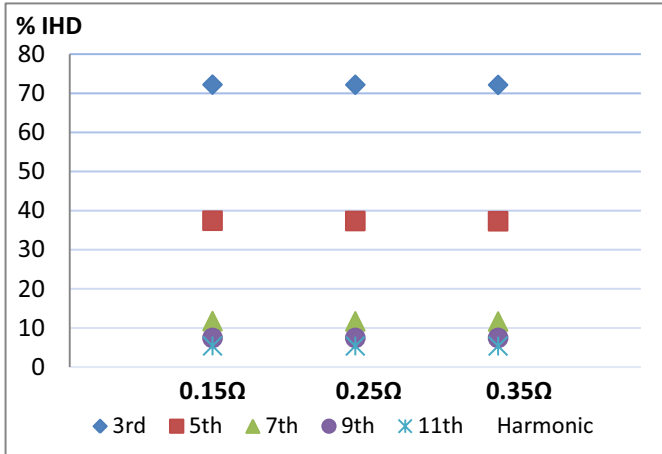

Fig. 8 Individual harmonics due to impedance variation (Simulation)

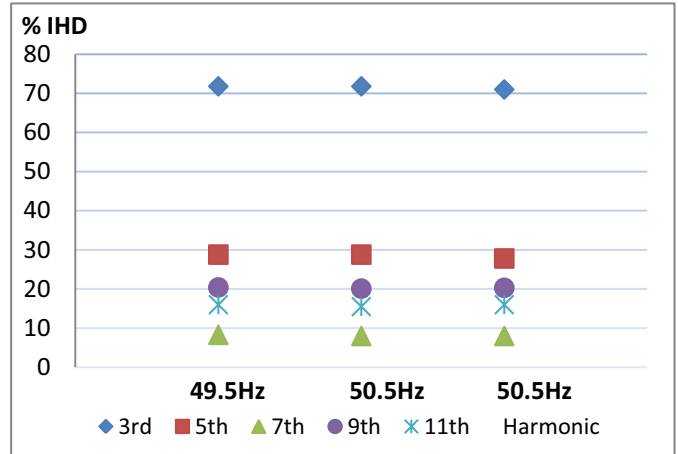

Fig. 10 Individual harmonics due to frequency variation (Measurement)

3.3 Frequency variation

In this case the system frequency has been changed to be 49.5, 50.0 and 50.5Hz. The source voltage is 240V and the source impedance is 0.25Ω. The effect of the frequency variation on the harmonics generated by the PC is similar to that caused by the source impedance variation described in section 3.2. Therefore, increasing the system frequency increases the system impedance which causes the current distortion to be decreased as shown in Fig. 9.

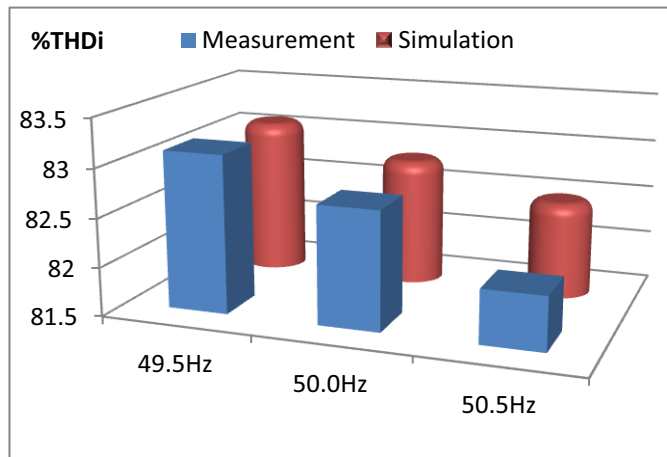

Fig. 9 THD due to frequency variation

Both measurements and simulation results shown in Figs. 10 and 11 illustrate that the effects of the system frequency variation on the individual harmonics are negligible as all of the indices up to the 11th order harmonic are almost unchanged.

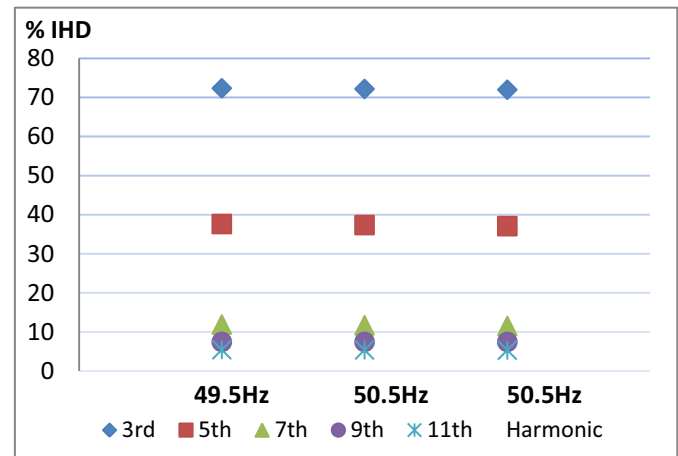

Fig. 11 Individual harmonics due to frequency variation (Simulation)

4 Effects of Vs, Zs and F variation on other power quantities

Many quantities were also monitored using the PPA1530 KinetiQ Power Analyzer such as power factor, active, nonactive and apparent power. The actual values for the four quantities at a 240V, 0.25Ω and 50Hz supply were 0.766, 117.3W, 153.2VAR and 98.6VA. The measurements prove that active power increases and decreases by less than 1% for increasing and decreasing the system voltage, respectively. However, the change in nonactive power could reach +3.35% with an increase of the voltage to 253V and -4.17% with a decrease to 227V system voltage. As a consequence, apparent power increases by 1.8% with an increase of voltage and decreases by about 2% with a decrease of voltage down to 227V. Fig. 12 demonstrates the effects of the voltage source variations on active, nonactive and apparent power. Very close results with a maximum error of 1% were also obtained from simulation.

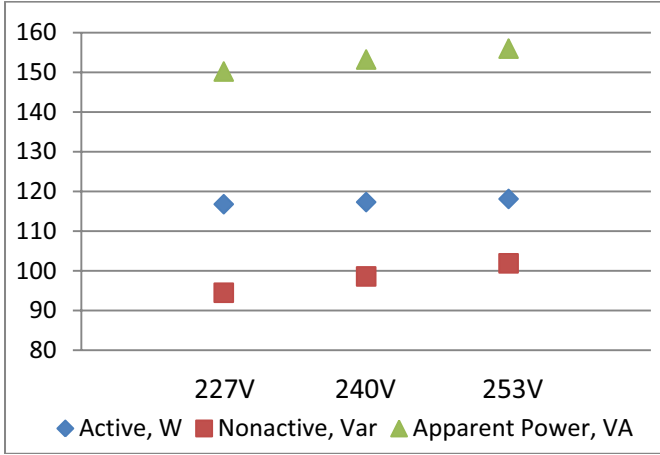

Fig. 12 Active, nonactive and apparent power (Measurement)

However, it can be seen from Fig. 13 that power factor follows different trend as it increases by about 1.55% at a low voltage of 227V and decreases by 1.09% with increasing voltage. This power factor trend is expected because THDi is inversely proportional to the power factor by the following equation [3, 12]:

$$PF = \frac{1}{\sqrt{1 + THD_i^2}} DPF \quad (2)$$

where PF is the power factor and DPF is the displacement power factor. This equation assumes that the voltage source is purely sinusoidal which is correct during all measurements using the Chroma power supply. Simulation with almost identical values to measurement also proves that power factor decreases as source voltage increases. Furthermore, it is clear that the PC under test has a low power factor with high THDi. This means that it is not equipped with a Power Factor Correction (PFC) circuit.

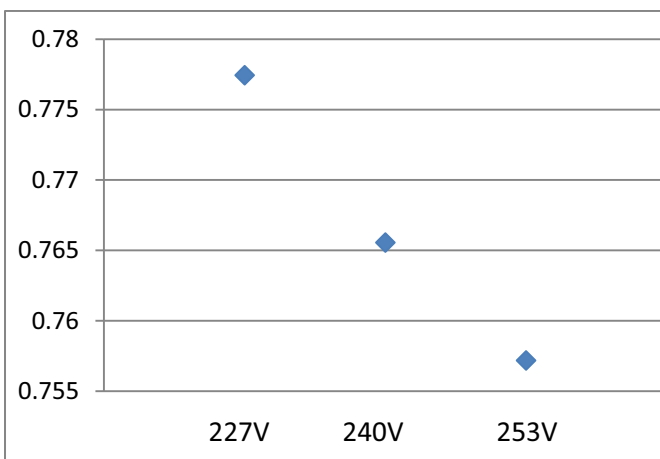

Fig. 13 Power factor (Measurement)

Finally, the effects of changing the source impedance or system frequency within the limits presented in the previous sections would cause power factor, active, nonactive and apparent power to vary by about $\pm 1\%$ only.

5 Conclusion

In conclusion, source voltage fluctuation causes THDi, individual harmonics, power factor, active and nonactive power to be changed. Increasing the source voltage increases THDi, active, nonactive and apparent power and the power factor decreases. Practical measurement shows that although most of the individual harmonic current increase with increasing source voltage, some harmonics might decrease. Furthermore, all measurements and simulations show that current distortion variations for a residential customer are negligible for source impedance and system frequency change within prescribed limits. However, current distortion slightly decreases as source impedance and system frequency increase.

Appendix A

Monitor	Samsung SyncMaster 172V
CPU	AMD Athlon 64 Processor 3000+ 2.01GHz, 2.00 GB of RAM
OS	Microsoft Windows XP Professional Version 2002 Service Pack 2
Power Supply	Trust 420W PSU Dual Fan PW-5210 (www.trust.com/15316)

Table A.1: Personal Computer Under Test Specifications

AC Output Rating	1- Φ Power	12 kVA
	3- Φ Power	12 kVA
	Power Per Phase	4 kVA
Voltage	Range	150v/300v/Auto
	Output Voltage	0~150v/0~300v
	Accuracy	0.2%+0.2%F.S.
	Distortion	0.3% @50/60Hz
Max. Current (Single Phase)	RMS	96A / 48A
	Peak (CF=4)	384A / 192A
Frequency	Range	DC, 15-1.5kHz
	Accuracy	0.15%
Phase Angle	Range	0 ~ 360°
	Resolution	0.3°
	Accuracy	<0.8°@50/60Hz

Table A.2: Chroma 61511 Specifications (Normal Mode)

Frequency Range	DC and 10mHz to 1MHz
Voltage Input	Ranges: 1Vpk to 2500Vpk (1000Vrms) in 8 ranges Accuracy: 0.05%Rdg +0.1%Rng +(0.005% x kHz) +5mV *
Current Input	Ranges: 100mApk to 300Apk (20Arms) in 8 ranges Accuracy: 0.05%Rdg +0.1%Rng +(0.005% x kHz) +500uA
Phase Accuracy	10 millidegrees+(10millidegreesxkHz)
Watts Accuracy	[0.1% +0.1%/pf +(0.01% x kHz)/pf] Rdg +0.1%VA Rng

* Rdg: Reading Rng: Range value

Table A.3: PPA 1500 Specifications

Acknowledgements

The authors would like to acknowledge King Abdulaziz University for their financial support of this PhD study.

References

- [1] J. C. Das, "Power System Analysis: Short-Circuit Load Flow and Harmonics", Marcel Dekker, (2002).
- [2] F. C. De La Rosa, "Harmonics and Power Systems", CRC Press, (2006).
- [3] N. Mohan, T. M. Undeland, and W. P. Robbins, "Power Electronics: Converters, Applications and Design", 3rd ed., New York: John Wiley & Sons, (2003).
- [4] R. C. Dugan, M. F. McGranaghan, S. Santoso, and H. W. Beaty, "Electrical Power System Quality", McGraw-Hill, (2003).
- [5] G. J. Wakileh, "Power Systems Harmonics: Fundamentals, Analysis and Filter Design", Springer, (2003).
- [6] A. Baggini, "Handbook of Power Quality", John Wiley & Sons, New York, (2008).
- [7] IEEE Standard 519-1992, "IEEE Recommended Practices and Requirements for Harmonic Control in Electrical Power Systems".
- [8] P. J. Moore and I.E. Portugués, "The influence of personal computer processing modes on line current harmonics", IEEE Transactions on power delivery, volume. 18, no. 4, October (2003).
- [9] "IEEE Standard Definitions for the Measurement of Electric Power Quantities Under Sinusoidal, Nonsinusoidal, Balanced, or Unbalanced Conditions," IEEE Std 1459-2010 (Revision of IEEE Std 1459-2000) , volume, no., pp.1-40, March 19 (2010).
- [10] MATLAB 7.10 (R2010a), MathWorks, Inc., (2010).
- [11] BS 7671:2008+A1:2011, "Requirements for electrical installations". IET Wiring Regulations. 7th edition.
- [12] The Grid Code, N. G. E. T. plc, CC.6.1.2, (2011).
- [13] (31 August 2011). Central Networks Supply Information. Available:<http://www.eonuk.com/distribution/electricians.aspx>
- [14] Programmable AC Source 61511/61512 User's Manual (Chroma), Chroma ATE INC., Version 1.1, August (2009), P/N A11 001293.
- [15] PPA1500 KinetiQ User Manual, Newtons4th Ltd, July (2010).
- [16] Rawa, M. J. H., Thomas, D.W.P and Sumner, M. "Simulation of Non-linear Loads for Harmonic Studies", The 11th IEEE EPQU2011 International Conference, 17-19 October (2011), Lisbon, Portugal.
- [17] IEC 61000-3-2:2005+A1:2008+A2:2009, Electromagnetic compatibility (EMC) - Part 3-2: Limits – "Limits for harmonic current emissions (equipment input current ≤ 16 A per phase)".
- [18] IEC/TR 61000-3-6 ed2.0, Electromagnetic compatibility (EMC) - Part 3-6: Limits – "Assessment of emission limits for the connection of distorting installations to MV, HV and EHV power systems".