

# Affordable Electricity for Bhashan Char from Renewable Energy

**M. J. M. Sunny**

Department of EEE  
Chittagong University of Engineering and  
Technology  
Chittagong, Bangladesh  
Email: jahedsunny@gmail.com

**M. A. Rahman**

Department of EEE  
Chittagong University of Engineering and  
Technology  
Chittagong, Bangladesh  
Email: rowdroxenon123@gmail.com

**M. A. Matin**

Professor  
Department of EEE  
Chittagong University of Engineering and  
Technology  
Chittagong, Bangladesh  
Email: imamatin@yahoo.com

**Abstract**—Bangladesh is a developing country with energy problem causing various after effects like load shedding, energy distribution & transmission. Major problem is population and adding more population may end in more scarcity of electricity distribution. Rohingya people fled away from Myanmar makes the number of population rising and energy problem is also increasing with more people as Bangladesh Government decided to relocate them in an island called Bhashan Char (Also known as Thenger Char, Char Piya). Bhashan Char is located at the southwest part of Bangladesh away from the main land and in the Bay of Bengal. Energy distribution from National grid is not a solution to the problem and as it is a remote area and detached from the main land transmission from the National grid is not feasible. The only solution is to provide electricity with renewable resources by means of PV, Wind or any other electricity generation systems. The HOMER simulation software was used for the design. The software also predicts the cost of electricity with sustainable manners. The proposed system has per unit electricity cost of 8.9 BDT.

**Keywords**— *Bhashan Char, HOMER, LCOE, PV, Solar-electricit.,*

## I. INTRODUCTION

Energy problem in Bangladesh is struggling issue to reach the demand of the energy of the people of the country as already around 180 to 200 million people live here on the main land. Maximum power generation capacity in Bangladesh is 15,953 MW and the generated unit is 10,958 MW [4]. The demand was that year is 14,014 MW and still unmet demand is 3,056 MW. To meet the unmet demand renewable energy use for generation of electricity would be the best solution. Bangladesh has a generation capacity of 3 MW [4] from solar PV system but the country need more attraction from renewable energy resources.

Recent outbreak of violence in Myanmar, the neighboring country makes so many Rohingya people to flee away from the country to Bangladesh and statistics from UN Refugee Agency shows around 582,000 people had entered till October 17, 2017 [6]. It seems that they have to stay in Bangladesh for a long time. The Bangladesh government has decided to rehabilitate these Rohingya in a new purpose-built camp to be built on Bhashan Char, a remote island under Hatiya Upazila in Noakhali [6]. For about 0.6 million people an energy crisis can be arrived

soon if we have to supply from our grid (Although it has to be a distribution system with high cost) or has to buy electricity for them. But both are practically not possible. Renewable energy can play a vital role in this regard.

Energy infrastructure of energy system of Bangladesh is poorly managed with insufficient management and efficient manpower. The per capita energy consumption is 227 kWh.

Distributing energy from National Grid is not feasible and initial cost for the transmission of energy to that kind of place is also impossible to implant with financial stabilities. For this kind of issues standalone PV system or any other Hybrid or Standalone system would be practical to implant. The simulation for the system was done by HOMER-Hybrid Optimization of Multiple Energy Resources simulation software. The proposed system for the island is Stand-alone Solar System for lower LCOE and other costs.

## II. LITERATURE REVIEW

Bhashan Char is a remote island which is completely detached from the main land of Bangladesh and the nearest land is Swandip Island which is almost inhabitable for better living. The island is also known as ‘Char Piya’ in Hatiya Upazila, with the coordinates  $22^{\circ} 22' 36.84''$  N,  $91^{\circ} 23' 45.96''$  E which is the remote island in the edge of Bay of Bengal, 37 miles from the coast. The island was formed with Himalayan silt in 2006 [7]. Fig 1. shows a satellite image of Bhashan Char.

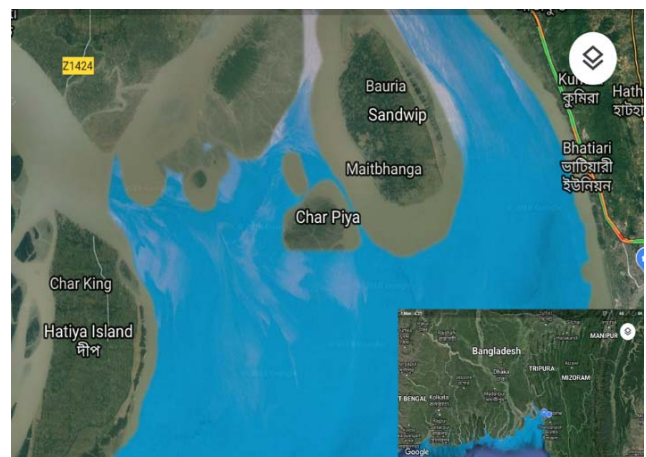

Fig. 1. Satellite image of Bhashan Char (Char Piya).

There are no people living at this time and due to problem occurred by the Rohingya people Bangladeshi Govt. decided to locate them separately. Around 70,000 to 100,000 people can be rehabilitated in the island and govt. almost completed the infrastructure for them. Fig 2. shows the recent satellite image which has the clear view of the houses built for rehabilitation.



Fig. 2. Houses built for the Rohingya people.

The island remains under water from June to September annually because of the monsoon, and it had no flood fences. There were no roads on the island. The island was formed by the billion tons of silt that flow every year from the peaks of the Himalayas to the turbulent water of Meghna River.

Similar works have been done before with simulation & cost analysis. The government took step on renewable energy encouragement with 7.5 MW off-grid PV-Wind Hybrid system with diesel generator in nearest Hatiya Island [1]. Island like Nizhum Dwip [1], Swandip [2], were also taken under consideration for study of feasibility. In Adorsho Char [3] which is off grid, studies were also been conducted. But feasibility study for Bhashan Char is yet to be done.

### III. LOAD PROFILE

Loads separated by the types of load and distributed through two dedicated lines. Lights, street lights and sockets are the types for the load distribution. Loads are selected as their living condition. Supplied loads by the proposed Stand-alone Solar system are bulbs and sockets for the rechargeable appliances like fan, search light, mobile phones etc. Table 1 shows the ratings of the unit loads.

TABLE 1: LOAD DESCRIPTION

Loads	Ratings	Unit
Lights	25	Watts
Sockets	15	Watts
Street lights	15	Watts

Attachment of 2 LED chargeable lights and one socket in each house and in total of 120 street lights are considered in that very area.

Stated before loads were distributed with separate dedicated lines by the type of loads and load variation through a day is still considered separately.

Fig 3. & Fig 4. shows the average load variation across a day generated by HOMER software for different loads.

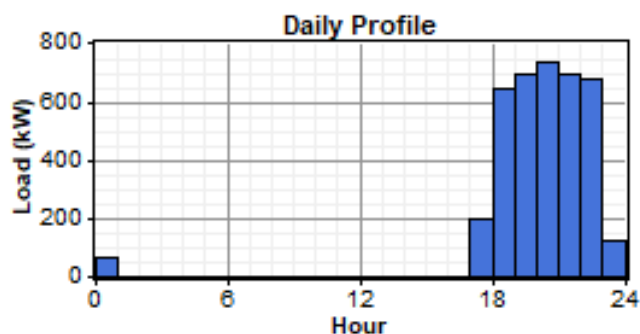

Fig. 3. Daily load variation of lights

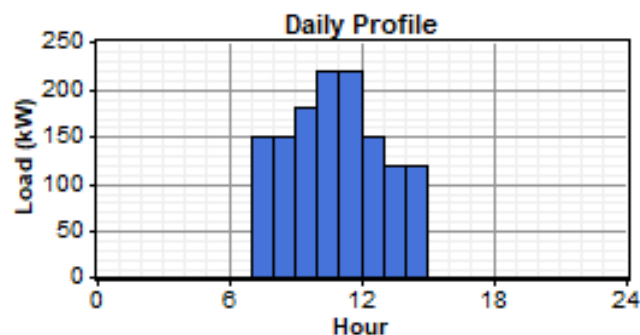

Fig.4 Daily load variation of socket.

A closer look on the DMap of the load can have the better observation of the load variation over a year. Fig 5 & Fig 6 shows DMap of the different types of load created in the HOMER software.

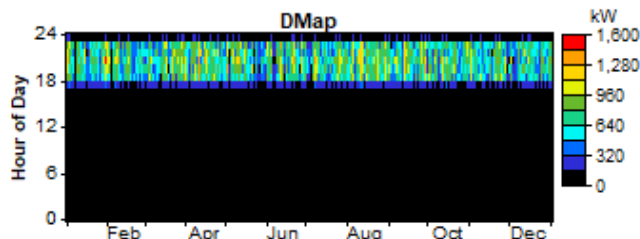

Fig. 5. Yearly load profile of Light Loads

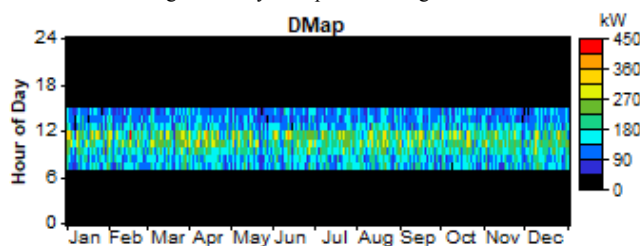

Fig. 6. Yearly load profile of Sockets

### IV. RENEWABLE RESOURCES

Different renewable resources is used for simulation. The data of these resources were collected from different sources.

#### A. Solar Energy

Solar energy is the most available renewable and clean energy among all the renewable energy resources. Solar irradiation is required by HOMER in order to calculate the solar energy produced by the solar panels. We collected monthly average direct normal radiation from 'Surface

Meteorology and Solar Energy' web site Sponsored by NASA's Applied Science Program. The baseline data is the set of 8,760 values representing the average global solar radiation on the horizontal surface, expressed in kWh/m<sup>2</sup>, for each hour of the year. HOMER displays the monthly average radiation and clearness index of the baseline data in the solar resource table and graph. From Fig 7., it is clear that the maximum irradiation is on the month of April and is 5.636 kWh/m<sup>2</sup>/day and the minimum is on the month of July and is 3.899 kWh/m<sup>2</sup>/day. Solar radiation is quite resourceful for the study.

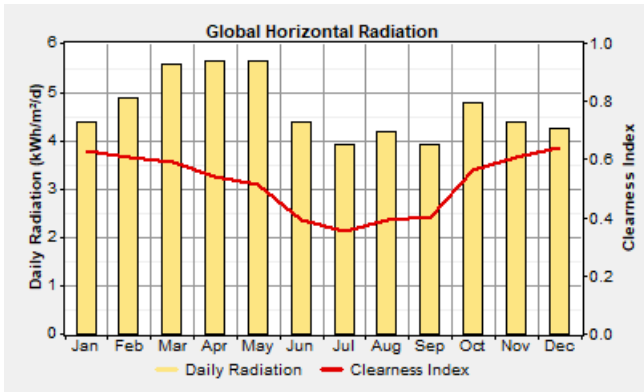

Fig. 7. Daily radiation and clearness index [5].

### B. Wind Resources

The strong south/south western monsoon wind come from the Indian Ocean travelling a long distance over the Bay of Bengal through the coastal area of Bangladesh. This wind blows over Bangladesh from March to September with a monthly average speed of 3 ms<sup>-1</sup> to 9 ms<sup>-1</sup> at different heights. Wind speed of Bangladesh is high during monsoon (7 months, March-September). In the rest months (October-February) wind speed remains either calm or too low. During the month of June and July, the peak wind speed is found [10]. 3.5 m/s is the typical cut-in speed, whenever a small turbine starts generating power.

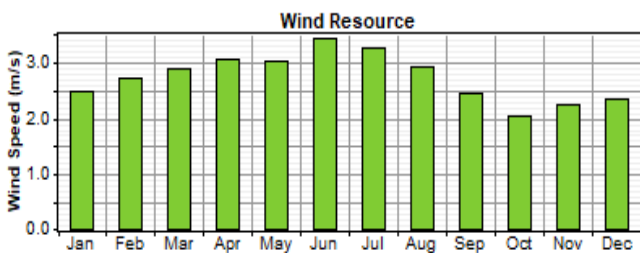

Fig. 8. Monthly average wind speed in Bhashan Char [5].

From the Fig 8. we can see that the highest wind speed is found in the month June, which is around 3.4m/s. It is below the cut-in speed to produce power. Thus we can say that, generating power from wind is not possible in this region.

### C. Biomass Energy

Bhashan Char is enriched with biomass sources like forest residue. In our research we found the area Bhashan Char has the enormous plantation project since 2010 governed by the forest authority in Hatiya Upazilla. After observing the place environment different types of plants are discovered for the biomass resources. Most of the plants are highly productive to use as biomass fuel, from where we can accumulate at least 40 ton of bio-plants per day. In the Fig 9. input of biomass resources for simulation is shown which is 40 ton of bio-plants per day.

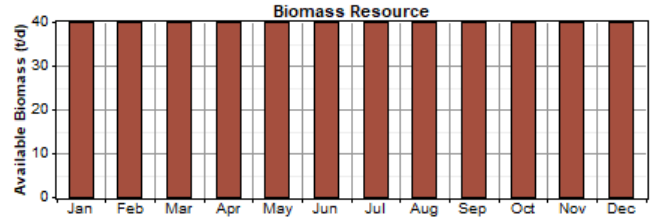

Fig. 9. Biomass resources.

## V. SYSTEM MODELLING

The proposed system is standalone solar system. As wind resource is not quite enough to generate electricity, Standalone Solar system is the main system to consider.

### A. PV Array

500,1000,1500,2200 kW sizes are considered without tracking & capital cost per kW was considered 36000 BDT. The height of the panel is around 4m from the ground to keep it safe from the tide. The lifetime of each panel have been considered 25 years with derating factor of 80% and replacement. Fig 10 shows the system design for the simulation in the HOMER software.

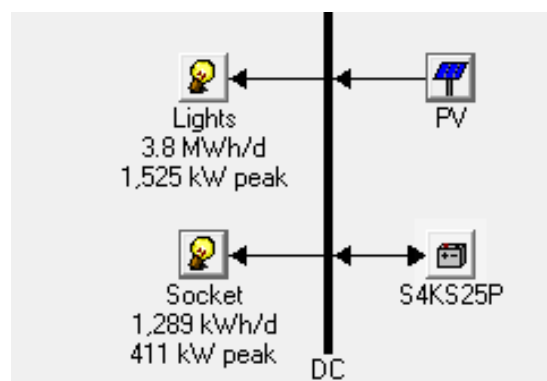

Fig. 10. SystemArchitecture

### B. Energy Storage

Batteries considered in the simulation for the energy storage. The Model used is S4KS25P with nominal voltage of 12V and string size of 3. Its throughput is considered to be 10,569kWh. The capital and replacement cost is

considered to be BDT 53,200 and BDT 45,600 respectively. The O&M cost is considered BDT 300 per year.

## VI. RESULT ANALYSIS

### A. Production

Production ratio defines how much we produce electricity per year with the percentage of the supply fraction. As we have made the simulation for standalone solar system, we have found that the annual energy production of this system will be 1.47 MWh per year with a supply fraction is 100%

TABLE 2: PRODUCTION FOR STANDALONE SOLAR SYSTEM

Component	Production	Fraction
	(kWh/yr)	%
PV array	1,470,603	100
Total	1,470,603	100

Monthly average electric production for Standalone Solar System is shown in the Fig 11.

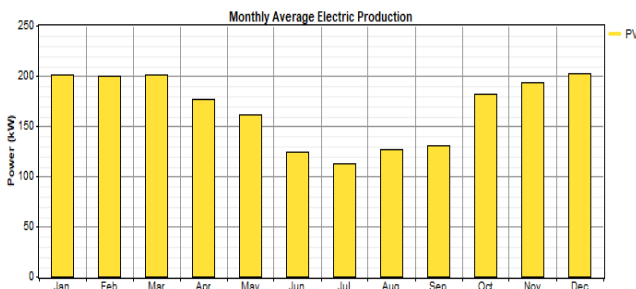

Fig. 11. Monthly average electric production for Standalone Solar System [5].

### B. Cost Analysis

The Levelized COE, net present cost, operating cost and carbon emission need to be discussed for the proposed systems.

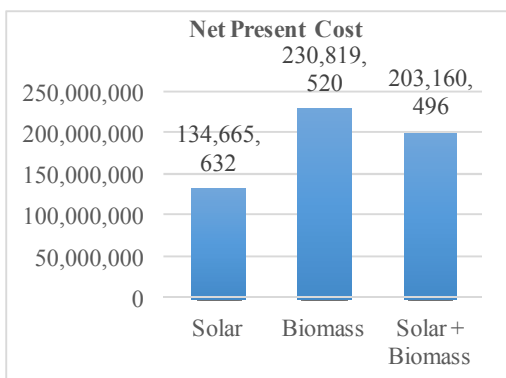

Fig. 12. Comparison among different technologies' NPC

From the Fig. 12. we can relate to that the net present cost of solar system is the lowest.

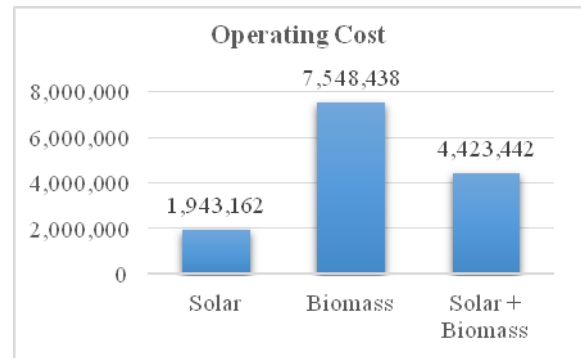

Fig. 13. Operating Cost comparison among different technologies. From the Fig. 13. Solar system has the lowest operating cost among the systems.

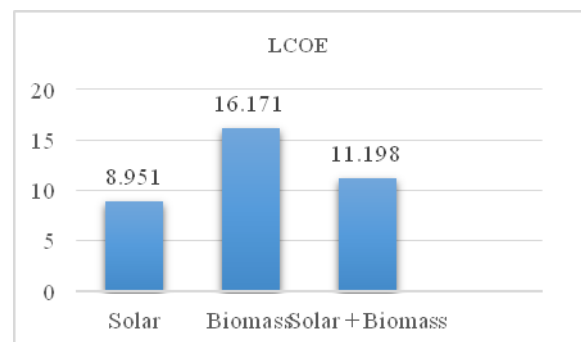

Fig. 14. LCOE comparison among different technologies. It is clear from the Fig. 14. the Solar system has the lowest LCOE of 8.951 BDT/kW compared to Solar & Biomass (11.2 BDT/kW ) and Biomass (16 BDT/kW ) individual systems.

## CONCLUSION

Developed energy solution can lessen the population management problem in main land of Bangladesh. For the low LCOE, we recommended the standalone solar system which has a levelized cost of electricity of 8.9 taka. Its low cost and 100% renewable fraction makes it a lucrative choice as generation system for Bhashan Char. The island isn't a proper living land now, but with proper planning of energy consumption following our thesis would lead the land inhabitable for around 1000,000 people. The proposed system may be extended for 1000,000 or more people.

## ACKNOWLEDGMENT

At the very beginning we would like to express our gratitude to the Almighty. We would also like to express our gratitude to Dept. of EEE, Chittagong University of Engineering and Technology and Renewable Energy Laboratory, CUET. At last our heartfelt thanks to Rohingya Camp Management Authority for supporting during our investigation about Rohingya people.

## REFERENCES

- [1] Md. Monir Hossain , Shuvro Barua , M. A. Matin,"A pre-feasibility study for electrification in Nijhum Dwip using hybrid renewable technology", 2015 International Conference on Electrical & Electronic Engineering (ICEEE),IEEE Xplore, Rajshahi, Bangladesh,pp. 225-228,Nov. 4-6,2015.
- [2] Nishat Anjum Khan ,Amit Kumar Sikder , Shamma Shananda Saha," Optimal planning of off-grid solar-wind-tidal hybrid energy system for sandwip island of Bangladesh", 2nd International Conference on Green Energy and Technology, IEEE Xplore, Dhaka, Bangladesh,pp. 41-44, Sept 5-6,2014.
- [3] Sayedus Salehin , A.K.M. Sadrul Islam ,Rawhatul Hoque , Mushfiqur Rahman ,Aynul Hoque , Emrul Manna," Optimized model of a solar PV-biogas-diesel hybrid energy system for Adorsho Char Island, Bangladesh", 2014 3rd International Conference on the Developments in Renewable Energy Technology (ICDRET), IEEE Xplore, Dhaka, Bangladesh,pp. 1-6, May 29-31,2014
- [4] Key statistics of Bangladesh Power Development board, [http://www.bpdb.gov.bd/bpdb\\_new/index.php/site/annual\\_reports\(13/11/2018\)](http://www.bpdb.gov.bd/bpdb_new/index.php/site/annual_reports(13/11/2018))
- [5] The HOMER energy website,[http://www.homerenergy.com/\(14/8/2018\)](http://www.homerenergy.com/(14/8/2018))
- [6] UN concern at Bangladesh plan to move thousands of Rohingya to flooded island". *The Guardian*. June 14, 2015. Retrieved February 25, 2017
- [7] The Trouble with Thengar Char". *Foreign Affairs*. Retrieved February 25, 2017. (28.09.2018)
- [8] NASA surface meteorology and solar energy website, [https://eosweb.larc.nasa.gov/cgi-bin/sse/grid.cgi/\(14/3/2016\)](https://eosweb.larc.nasa.gov/cgi-bin/sse/grid.cgi/(14/3/2016))
- [9] World Energy Date: [www.worlddata.info/asia/bangladesh/energy-consumption.php](http://www.worlddata.info/asia/bangladesh/energy-consumption.php) (Date: 13 September, 2018)].
- [10] N. A. Masood, R. Mirza, J. Ahmed, A. H. Abedin, S.R.Deeba, F. Hafiz, M. Begum , A. H. Chowdhury, " Design of a Cost Effective Wind-Diesel Hybrid Power System in an Island of Bangladesh", World Academy of Science, Engineering and Technology 60 2011